

## Dual-Output PWM Controller for AMD SVI2 CPU Power Supply

### General Description

The RT8877C is a 4 + 2 phases PWM controller. Moreover, it is compliant with AMD SVI2 Voltage Regulator Specification to support both CPU core (VDD) and Northbridge portion of the CPU (VDDNB). The RT8877C features CCRCOT (Constant Current Ripple Constant On-Time) with G-NAVP (Green-Native AVP), which is a Richtek's proprietary topology. G-NAVP makes it an easy setting controller to meet all AMD AVP (Active Voltage Positioning) VDD/VDDNB requirements. The droop is easily programmed by setting the DC gain of the error amplifier. With proper compensation, the load transient response can achieve optimized AVP performance. The controller also uses the interface to issue VOTF Complete and to send digitally encoded voltage and current values for the VDD and VDDNB domains. It can operate in single phase and diode emulation mode and reach up to 90% efficiency in different modes according to different loading conditions. The RT8877C provides special purpose offset capabilities by pin setting. The RT8877C also provides power good indication, over current indication (OCP\_L) and dual OCP mechanism for AMD SVI2 CPU core and NB. It also features complete fault protection functions including over voltage, under voltage and negative voltage.

### Features

- 4/3/2/1-Phase (VDD) + 2/1/0-Phase (VDDNB) PWM Controller
- G-NAVP™ Topology
- Support Dynamic Load Line and Zero Load Line
- Diode Emulation Mode at Light Load Condition
- SVI2 Interface to Comply AMD Power Management Protocol
- Build-In ADC for V<sub>OUT</sub> and I<sub>OUT</sub> Reporting
- Immediate OV, UV and NV Protections and UVLO
- Programmable Dual OCP Mechanism
- 0.5% DAC Accuracy
- Fast Transient Response
- Power Good Indicator
- Over Current Indicator
- 52-Lead WQFN Package
- RoHS Compliant and Halogen Free

### Applications

- AMD SVI2 CPU
- Desktop Computer

### Simplified Application Circuit

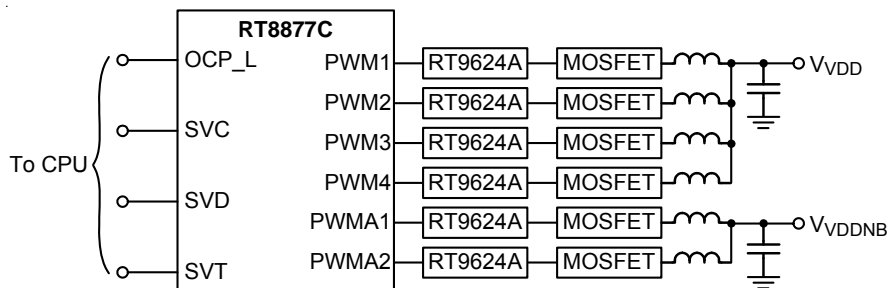

## Ordering Information

RT8877C □ □

- Package Type  
QW : WQFN-52L 6x6 (W-Type)
- Lead Plating System  
Z : ECO (Ecological Element with Halogen Free and Pb free)

Note :

Richtek products are :

- ▶ RoHS compliant and compatible with the current requirements of IPC/JEDEC J-STD-020.
- ▶ Suitable for use in SnPb or Pb-free soldering processes.

## Marking Information

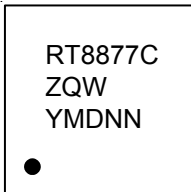

RT8877CZQW : Product Number  
YMDNN : Date Code

## Pin Configuration

(TOP VIEW)

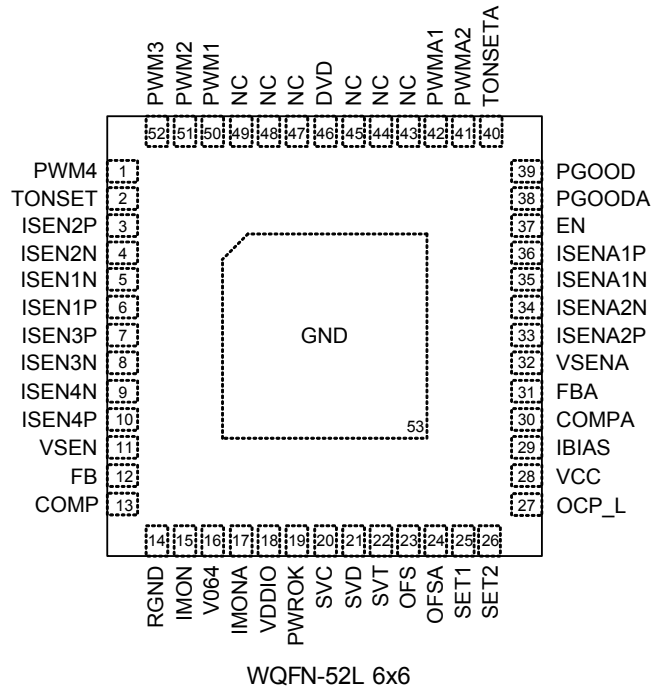

**Functional Pin Description**

| Pin No.       | Pin Name         | Pin Function  |
|---------------|------------------|---|
| 1, 52, 51, 50 | PWM4 to PWM1     | PWM outputs for Channel 1, 2, 3 and 4 of VDD controller.  |
| 2             | TONSET           | VDD controller on-time setting. Connect this pin to the converter input voltage, VIN, through a resistor, RTON, to set the on-time of UGATE and also the output voltage ripple of VDD controller.   |
| 5, 4, 8, 9    | ISEN1N to ISEN4N | Negative current sense input of Channel 1, 2, 3 and 4 for VDD controller.   |
| 6, 3, 7, 10   | ISEN1P to ISEN4P | Positive current sense input of Channel 1, 2, 3 and 4 for VDD controller.   |
| 11            | VSEN             | VDD controller voltage sense input. This pin is connected to the terminal of VDD controller output voltage.   |
| 12            | FB               | Output voltage feedback input of VDD controller. This pin is the negative input of the error amplifier for the VDD controller.  |
| 13            | COMP             | Error amplifier output pin of the VDD controller.   |
| 14            | RGND             | Return ground of VDD and VDDNB controller. This pin is the common negative input of output voltage differential remote sense for VDD and VDDNB controllers.   |
| 15            | IMON             | Current monitor output for the VDD controller. This pin outputs a voltage proportional to the output current.   |
| 16            | V064             | Fixed 0.64V Reference voltage output. This voltage is only used to offset the output voltage of IMON pin and IMONA pin. Connect a 0.47 $\mu$ F capacitor from this pin to GND.  |
| 17            | IMONA            | Current monitor output for the VDDNB controller. This pin outputs a voltage proportional to the output current.   |
| 18            | VDDIO            | Processor memory interface power rail and serves as the reference for PWROK, SVD, SVC and SVT. This pin is used by the VR to reference the SVI pins.  |
| 19            | PWROK            | System power good input. If PWROK is low, the SVI interface is disabled and VR returns to BOOT-VID state with initial load line slope and initial offset. If PWROK is high, the SVI interface is running and the DAC decodes the received serial VID codes to determine the output voltage. |
| 20            | SVC              | Serial VID clock input from processor.  |
| 21            | SVD              | Serial VID data input from processor. This pin is a serial data line.   |
| 22            | SVT              | Serial VID telemetry input from VR. This pin is a push-pull output.   |
| 23            | OFS              | Over clocking offset setting for the VDD controller.  |
| 24            | OFSA             | Over clocking special purpose offset setting for the VDDNB controller.  |
| 25            | SET1             | OCP_TDC threshold setting individually for VDD and VDDNB controllers and also the internal ramp slew rate setting (RSET and RSETA) individually for VDD and VDDNB controllers   |
| 26            | SET2             | Quick response threshold setting individually for VDD and VDDNB controllers (QRTH and QRTHA) and also the OCP_TDC trigger delay time setting for both controllers and over clocking offset enable setting.  |
| 27            | OCP_L            | Over current indicator for dual OCP mechanism. This pin is an open drain output.  |
| 28            | VCC              | Controller power supply input. Connect this pin to 5V with a 1 $\mu$ F or greater ceramic capacitor for decoupling.   |

| Pin No.                   | Pin Name            | Pin Function  |
|---------------------------|---------------------|---|
| 29                        | IBIAS               | Internal bias current setting. Connect only a 100kΩ resistor from this pin to GND to generate bias current for internal circuit. Place this resistor as close to IBIAS pin as possible.                       |
| 30                        | COMPA               | Error amplifier output of the VDDNB controller.   |
| 31                        | FBA                 | Output voltage feedback input of VDDNB controller. This pin is the negative input of the error amplifier for the VDDNB controller.  |
| 32                        | VSENA               | VDDNB controller voltage sense input. This pin is connected to the terminal of VDDNB controller output voltage.   |
| 33, 36                    | ISENA2P,<br>ISENA1P | Positive current sense input of Channel 1 and 2 for VDDNB controller.   |
| 34, 35                    | ISENA2N,<br>ISENA1N | Negative current sense input of Channel 1 and 2 for VDDNB controller.   |
| 37                        | EN                  | Controller enable pin. A logic high signal enables the controller.  |
| 38                        | PGOODA              | Power good indicator for the VDDNB controller. This pin is an open drain output.  |
| 39                        | PGOOD               | Power good indicator for the VDD controller. This pin is an open drain output.  |
| 40                        | TONSETA             | VDDNB controller on-time setting. Connect this pin to the converter input voltage, VIN, through a resistor, RTONNB, to set the on-time of UGATE_VDDNB and also the output voltage ripple of VDDNB controller. |
| 41, 42                    | PWMA2,<br>PWMA1     | PWM output for Channel 1 and 2 of VDDNB controller.   |
| 43, 44, 45,<br>47, 48, 49 | NC                  | No internal connection.   |
| 46                        | DVD                 | External driver power supply input voltage detection pin.   |
| 53 (Exposed Pad)          | GND                 | Ground. The exposed pad must be soldered to a large PCB and connected to GND for maximum power dissipation.   |

**Functional Block Diagram**

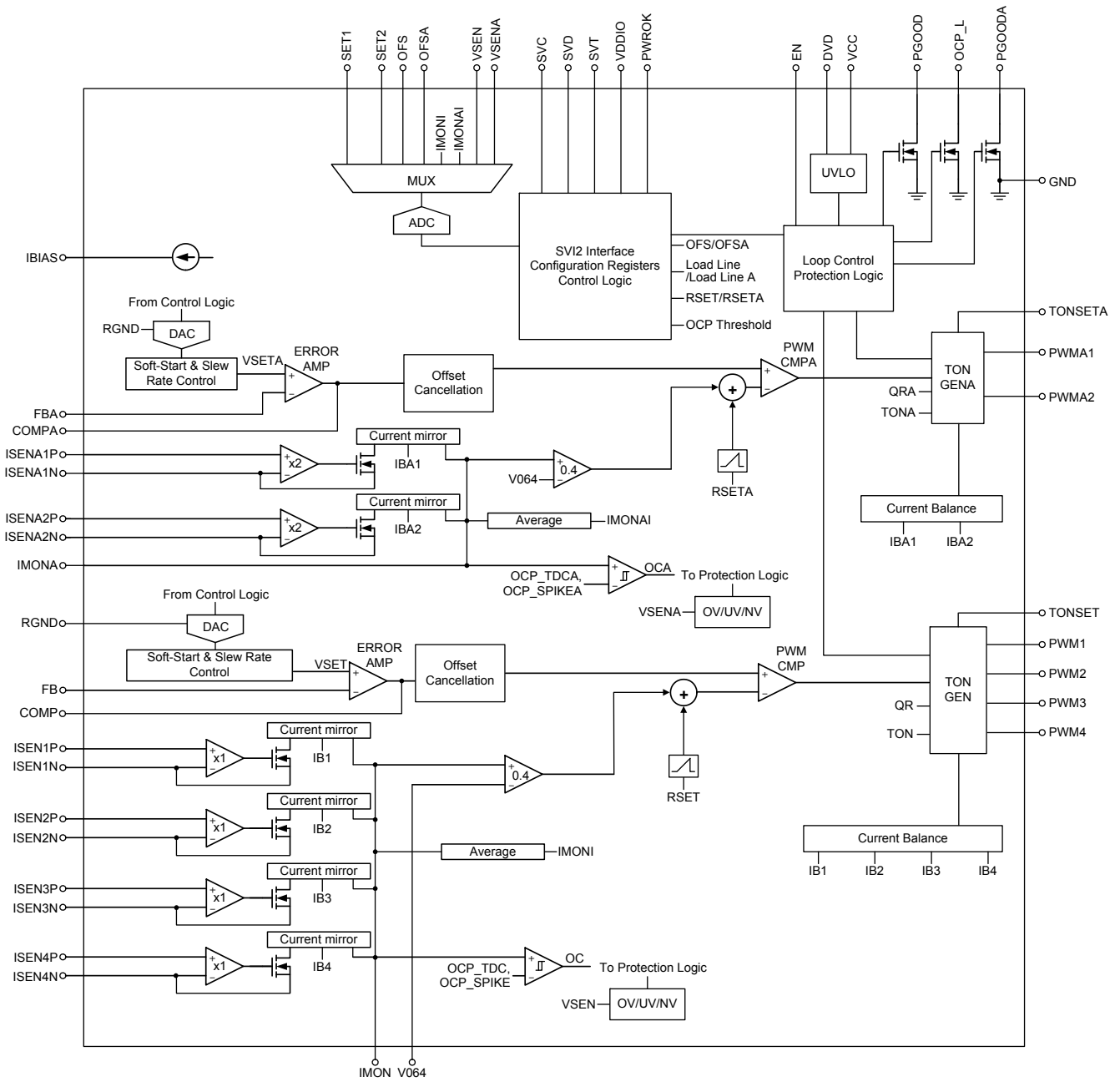

## Operation

### MUX and ADC

The MUX supports the inputs from SET1, SET2, OFS, OFSA, IMON, IMONA, VSEN, or VSENA. The ADC converts these analog signals to digital codes for reporting or performance adjustment.

### SVI2 Interface

The SVI2 interface uses SVC, SVD, and SVT pins to communicate with CPU. RT8877C's performance and behavior can be adjusted by commands sent by CPU or platform.

### UVLO

The UVLO detects DVD and VCC pin voltages for under voltage lockout protection and power on reset operation.

### Loop Control Protection Logic

Loop control protection logic detects EN and UVLO signals to initiate soft-start function and control PGOOD, PGOODA and OCP\_L signals after soft-start is finished. When OCP event is triggered, the OCP\_L pin voltage will be pulled low.

### DAC

The DAC receives VID codes from the SVI2 control logic to generate an internal reference voltage (VSET/VSETA) for controller.

### Soft-Start and Slew-Rate Control

This block controls the slew rate of the internal reference voltage when output voltage changes.

### Error Amp

Error amplifier generates COMP/COMP<sub>A</sub> signal by the difference between VSET/VSETA and FB/FBA.

### Offset cancellation

This block cancels the output offset voltage from voltage ripple and current ripple to achieve accurate output voltage.

### PWM CMP<sub>x</sub>

The PWM comparator compares COMP signal and current feedback signal to generate a signal for TONGEN<sub>x</sub>.

### TONGEN/TONGENA

This block generates an on-time pulse which high interval is based on the on-time setting and current balance.

### Current Balance

Per-phase current is sensed and adjusted by adjusting on-time of each phase to achieve current balance for each phase.

### OC/OV/UV/NV

VSEN/VSENA and output current are sensed for over current, over voltage, under voltage, and negative voltage protection.

### RSET/RSETA

The Ramp generator is designed to improve noise immunity and reduce jitter.

**Table 1. Serial VID Codes**

| SVID [7:0] | Voltage (V) | SVID [7:0] | Voltage (V) | SVID [7:0] | Voltage (V) | SVID [7:0] | Voltage (V) |
|------------|-------------|------------|-------------|------------|-------------|------------|-------------|
| 0000_0000  | 1.55000     | 0010_0111  | 1.30625     | 0100_1110  | 1.06250     | 0111_0101  | 0.81875     |
| 0000_0001  | 1.54375     | 0010_1000  | 1.30000     | 0100_1111  | 1.05625     | 0111_0110  | 0.81250     |
| 0000_0010  | 1.53750     | 0010_1001  | 1.29375     | 0101_0000  | 1.05000     | 0111_0111  | 0.80625     |
| 0000_0011  | 1.53125     | 0010_1010  | 1.28750     | 0101_0001  | 1.04375     | 0111_1000  | 0.80000     |
| 0000_0100  | 1.52500     | 0010_1011  | 1.28125     | 0101_0010  | 1.03750     | 0111_1001  | 0.79375     |
| 0000_0101  | 1.51875     | 0010_1100  | 1.27500     | 0101_0011  | 1.03125     | 0111_1010  | 0.78750     |
| 0000_0110  | 1.51250     | 0010_1101  | 1.26875     | 0101_0100  | 1.02500     | 0111_1011  | 0.78125     |
| 0000_0111  | 1.50625     | 0010_1110  | 1.26250     | 0101_0101  | 1.01875     | 0111_1100  | 0.77500     |
| 0000_1000  | 1.50000     | 0010_1111  | 1.25625     | 0101_0110  | 1.01250     | 0111_1101  | 0.76875     |
| 0000_1001  | 1.49375     | 0011_0000  | 1.25000     | 0101_0111  | 1.00625     | 0111_1110  | 0.76250     |
| 0000_1010  | 1.48750     | 0011_0001  | 1.24375     | 0101_1000  | 1.00000     | 0111_1111  | 0.75625     |
| 0000_1011  | 1.48125     | 0011_0010  | 1.23750     | 0101_1001  | 0.99375     | 1000_0000  | 0.75000     |
| 0000_1100  | 1.47500     | 0011_0011  | 1.23125     | 0101_1010  | 0.98750     | 1000_0001  | 0.74375     |
| 0000_1101  | 1.46875     | 0011_0100  | 1.22500     | 0101_1011  | 0.98125     | 1000_0010  | 0.73750     |
| 0000_1110  | 1.46250     | 0011_0101  | 1.21875     | 0101_1100  | 0.97500     | 1000_0011  | 0.73125     |
| 0000_1111  | 1.45625     | 0011_0110  | 1.21250     | 0101_1101  | 0.96875     | 1000_0100  | 0.72500     |
| 0001_0000  | 1.45000     | 0011_0111  | 1.20625     | 0101_1110  | 0.96250     | 1000_0101  | 0.71875     |
| 0001_0001  | 1.44375     | 0011_1000  | 1.20000     | 0101_1111  | 0.95625     | 1000_0110  | 0.71250     |
| 0001_0010  | 1.43750     | 0011_1001  | 1.19375     | 0110_0000  | 0.95000     | 1000_0111  | 0.70625     |
| 0001_0011  | 1.43125     | 0011_1010  | 1.18750     | 0110_0001  | 0.94375     | 1000_1000  | 0.70000     |
| 0001_0100  | 1.42500     | 0011_1011  | 1.18125     | 0110_0010  | 0.93750     | 1000_1001  | 0.69375     |
| 0001_0101  | 1.41875     | 0011_1100  | 1.17500     | 0110_0011  | 0.93125     | 1000_1010  | 0.68750     |
| 0001_0110  | 1.41250     | 0011_1101  | 1.16875     | 0110_0100  | 0.92500     | 1000_1011  | 0.68125     |
| 0001_0111  | 1.40625     | 0011_1110  | 1.16250     | 0110_0101  | 0.91875     | 1000_1100  | 0.67500     |
| 0001_1000  | 1.40000     | 0011_1111  | 1.15625     | 0110_0110  | 0.91250     | 1000_1101  | 0.66875     |
| 0001_1001  | 1.39375     | 0100_0000  | 1.15000     | 0110_0111  | 0.90625     | 1000_1110  | 0.66250     |
| 0001_1010  | 1.38750     | 0100_0001  | 1.14375     | 0110_1000  | 0.90000     | 1000_1111  | 0.65625     |
| 0001_1011  | 1.38125     | 0100_0010  | 1.13750     | 0110_1001  | 0.89375     | 1001_0000  | 0.65000     |
| 0001_1100  | 1.37500     | 0100_0011  | 1.13125     | 0110_1010  | 0.88750     | 1001_0001  | 0.64375     |
| 0001_1101  | 1.36875     | 0100_0100  | 1.12500     | 0110_1011  | 0.88125     | 1001_0010  | 0.63750     |
| 0001_1110  | 1.36250     | 0100_0101  | 1.11875     | 0110_1100  | 0.87500     | 1001_0011  | 0.63125     |
| 0001_1111  | 1.35625     | 0010_0110  | 1.11250     | 0110_1101  | 0.86875     | 1001_0100  | 0.62500     |
| 0010_0000  | 1.35000     | 0100_0111  | 1.10625     | 0110_1110  | 0.86250     | 1001_0101  | 0.61875     |
| 0010_0001  | 1.34375     | 0100_1000  | 1.10000     | 0110_1111  | 0.85625     | 1001_0110  | 0.61250     |
| 0010_0010  | 1.33750     | 0100_1001  | 1.09375     | 0111_0000  | 0.85000     | 1001_0111  | 0.60625     |
| 0010_0011  | 1.33125     | 0100_1010  | 1.08750     | 0111_0001  | 0.84375     | 1001_1000  | 0.60000     |
| 0010_0100  | 1.32500     | 0100_1011  | 1.08125     | 0111_0010  | 0.83750     | 1001_1001  | 0.59375     |
| 0010_0101  | 1.31875     | 0100_1100  | 1.07500     | 0111_0011  | 0.83125     | 1001_1010  | 0.58750     |
| 0010_0110  | 1.31250     | 0100_1101  | 1.06875     | 0111_0100  | 0.82500     | 1001_1011  | 0.58125     |

| SVID [7:0]  | Voltage (V) | SVID [7:0]  | Voltage (V) | SVID [7:0]  | Voltage (V) | SVID [7:0] | Voltage (V) |
|-------------|-------------|-------------|-------------|-------------|-------------|------------|-------------|
| 1001_1100   | 0.57500     | 1011_0101 * | 0.41875     | 1100_1110 * | 0.26250     | 1110_0111* | 0.10625     |
| 1001_1101   | 0.56875     | 1011_0110 * | 0.41250     | 1100_1111 * | 0.25625     | 1110_1000* | 0.10000     |
| 1001_1110   | 0.56250     | 1011_0111 * | 0.40625     | 1101_0000 * | 0.25000     | 1110_1001* | 0.09375     |
| 1001_1111   | 0.55625     | 1011_1000 * | 0.40000     | 1101_0001 * | 0.24375     | 1110_1010* | 0.08750     |
| 1010_0000   | 0.55000     | 1011_1001 * | 0.39375     | 1101_0010 * | 0.23750     | 1110_1011* | 0.08125     |
| 1010_0001   | 0.54375     | 1011_1010 * | 0.38750     | 1101_0011 * | 0.23125     | 1110_1100* | 0.07500     |
| 1010_0010   | 0.53750     | 1011_1011 * | 0.38125     | 1101_0100 * | 0.22500     | 1110_1101* | 0.06875     |
| 1010_0011   | 0.53125     | 1011_1100 * | 0.37500     | 1101_0101 * | 0.21875     | 1110_1110* | 0.06250     |
| 1010_0100   | 0.52500     | 1011_1101 * | 0.36875     | 1101_0110 * | 0.21250     | 1110_1111* | 0.05625     |
| 1010_0101   | 0.51875     | 1011_1110 * | 0.36250     | 1101_0111 * | 0.20625     | 1111_0000* | 0.05000     |
| 1010_0110   | 0.51250     | 1011_1111 * | 0.35625     | 1101_1000 * | 0.20000     | 1111_0001* | 0.04375     |
| 1010_0111   | 0.50625     | 1100_0000 * | 0.35000     | 1101_1001 * | 0.19375     | 1111_0010* | 0.03750     |
| 1010_1000 * | 0.50000     | 1100_0001 * | 0.34375     | 1101_1010 * | 0.18750     | 1111_0011* | 0.03125     |
| 1010_1001 * | 0.49375     | 1100_0010 * | 0.33750     | 1101_1011 * | 0.18125     | 1111_0100* | 0.02500     |
| 1010_1010 * | 0.48750     | 1100_0011 * | 0.33125     | 1101_1100 * | 0.17500     | 1111_0101* | 0.01875     |
| 1010_1011 * | 0.48125     | 1100_0100 * | 0.32500     | 1101_1101 * | 0.16875     | 1111_0110* | 0.01250     |
| 1010_1100 * | 0.47500     | 1100_0101 * | 0.31875     | 1101_1110 * | 0.16250     | 1111_0111* | 0.00625     |
| 1010_1101 * | 0.46875     | 1100_0110 * | 0.31250     | 1101_1111 * | 0.15625     | 1111_1000* | 0.00000     |
| 1010_1110 * | 0.46250     | 1100_0111 * | 0.30625     | 1110_0000*  | 0.15000     | 1111_1001* | OFF         |
| 1010_1111 * | 0.45625     | 1100_1000 * | 0.30000     | 1110_0001*  | 0.14375     | 1111_1010* | OFF         |
| 1011_0000 * | 0.45000     | 1100_1001 * | 0.29375     | 1110_0010*  | 0.13750     | 1111_1011* | OFF         |
| 1011_0001 * | 0.44375     | 1100_1010 * | 0.28750     | 1110_0011*  | 0.13125     | 1111_1100* | OFF         |
| 1011_0010 * | 0.43750     | 1100_1011 * | 0.28125     | 1110_0100*  | 0.12500     | 1111_1101* | OFF         |
| 1011_0011 * | 0.43125     | 1100_1100 * | 0.27500     | 1110_0101*  | 0.11875     | 1111_1110* | OFF         |
| 1011_0100 * | 0.42500     | 1100_1101 * | 0.26875     | 1110_0110*  | 0.11250     | 1111_1111* | OFF         |

\* Indicates TOB is 80mV for this VID code; unconditional VR controller stability required at all VID codes



**Table 2. SET1 Pin Setting for VDD Controller**

| SET1 Pin Voltage Before Current Injection $V_{SET1}$ (mV) | OCP_TDC (Respect to OCP_SPIKE) | RSET | SET1 Pin Voltage Before Current Injection $V_{SET1}$ (mV) | OCP_TDC (Respect to OCP_SPIKE) | RSET |
|---|--------------------------------|------|---|--------------------------------|------|
| 34  | 45%                            | 145% | 836   | 65%                            | 145% |
| 59  |                                | 130% | 861   |                                | 130% |
| 85  |                                | 115% | 886   |                                | 115% |
| 110   |                                | 100% | 911   |                                | 100% |
| 135   |                                | 85%  | 936   |                                | 85%  |
| 160   |                                | 70%  | 961   |                                | 70%  |
| 235   | 50%                            | 145% | 1036  | 70%                            | 145% |
| 260   |                                | 130% | 1061  |                                | 130% |
| 285   |                                | 115% | 1086  |                                | 115% |
| 310   |                                | 100% | 1112  |                                | 100% |
| 335   |                                | 85%  | 1137  |                                | 85%  |
| 360   |                                | 70%  | 1162  |                                | 70%  |
| 435   | 55%                            | 145% | 1237  | 75%                            | 145% |
| 460   |                                | 130% | 1262  |                                | 130% |
| 485   |                                | 115% | 1287  |                                | 115% |
| 510   |                                | 100% | 1312  |                                | 100% |
| 535   |                                | 85%  | 1337  |                                | 85%  |
| 560   |                                | 70%  | 1362  |                                | 70%  |
| 636   | 60%                            | 145% | 1437  | Disable                        | 145% |
| 661   |                                | 130% | 1462  |                                | 130% |
| 686   |                                | 115% | 1487  |                                | 115% |
| 711   |                                | 100% | 1512  |                                | 100% |
| 736   |                                | 85%  | 1537  |                                | 85%  |
| 761   |                                | 70%  | 1562  |                                | 70%  |

Table 3. SET1 Pin Setting for VDDNB Controller

| SET1 Pin Voltage Difference $\Delta V_{SET1}$ (Before and After Current Injection) (mV) | OCP_TDCA (Respect to OCP_SPIKEA) | RSETA | SET1 Pin Voltage Difference $\Delta V_{SET1}$ (Before and After Current Injection) (mV) | OCP_TDCA (Respect to OCP_SPIKEA) | RSETA |
|---|----------------------------------|-------|---|----------------------------------|-------|
| 34  | 45%                              | 145%  | 836   | 65%                              | 145%  |
| 59  |                                  | 130%  | 861   |                                  | 130%  |
| 85  |                                  | 115%  | 886   |                                  | 115%  |
| 110   |                                  | 100%  | 911   |                                  | 100%  |
| 135   |                                  | 85%   | 936   |                                  | 85%   |
| 160   |                                  | 70%   | 961   |                                  | 70%   |
| 235   | 50%                              | 145%  | 1036  | 70%                              | 145%  |
| 260   |                                  | 130%  | 1061  |                                  | 130%  |
| 285   |                                  | 115%  | 1086  |                                  | 115%  |
| 310   |                                  | 100%  | 1112  |                                  | 100%  |
| 335   |                                  | 85%   | 1137  |                                  | 85%   |
| 360   |                                  | 70%   | 1162  |                                  | 70%   |
| 435   | 55%                              | 145%  | 1237  | 75%                              | 145%  |
| 460   |                                  | 130%  | 1262  |                                  | 130%  |
| 485   |                                  | 115%  | 1287  |                                  | 115%  |
| 510   |                                  | 100%  | 1312  |                                  | 100%  |
| 535   |                                  | 85%   | 1337  |                                  | 85%   |
| 560   |                                  | 70%   | 1362  |                                  | 70%   |
| 636   | 60%                              | 145%  | 1437  | Disable                          | 145%  |
| 661   |                                  | 130%  | 1462  |                                  | 130%  |
| 686   |                                  | 115%  | 1487  |                                  | 115%  |
| 711   |                                  | 100%  | 1512  |                                  | 100%  |
| 736   |                                  | 85%   | 1537  |                                  | 85%   |
| 761   |                                  | 70%   | 1562  |                                  | 70%   |

**Table 4. SET2 Pin Setting**

| SET2 Pin Voltage<br>Before Current Injection $V_{SET2}$ (mV) | QRTH<br>(for VDD) | OCPTRGDELAY<br>[1:0] | OCPTRGDELAY<br>(for VDD/VDDNB) |
|--|-------------------|----------------------|--------------------------------|
| 19   | Disable           | 00                   | 10ms                           |
| 72   |                   | 01                   | 20ms                           |
| 122  |                   | 10                   | 30ms                           |
| 172  |                   | 11                   | 40ms                           |
| 222  | 35mV              | 00                   | 10ms                           |
| 272  |                   | 01                   | 20ms                           |
| 323  |                   | 10                   | 30ms                           |
| 373  |                   | 11                   | 40ms                           |
| 423  | 39mV              | 00                   | 10ms                           |
| 473  |                   | 01                   | 20ms                           |
| 523  |                   | 10                   | 30ms                           |
| 573  |                   | 11                   | 40ms                           |
| 623  | 43mV              | 00                   | 10ms                           |
| 673  |                   | 01                   | 20ms                           |
| 723  |                   | 10                   | 30ms                           |
| 773  |                   | 11                   | 40ms                           |
| 823  | 47mV              | 00                   | 10ms                           |
| 874  |                   | 01                   | 20ms                           |
| 924  |                   | 10                   | 30ms                           |
| 974  |                   | 11                   | 40ms                           |
| 1024   | 51mV              | 00                   | 10ms                           |
| 1074   |                   | 01                   | 20ms                           |
| 1124   |                   | 10                   | 30ms                           |
| 1174   |                   | 11                   | 40ms                           |
| 1224   | 55mV              | 00                   | 10ms                           |
| 1274   |                   | 01                   | 20ms                           |
| 1324   |                   | 10                   | 30ms                           |
| 1375   |                   | 11                   | 40ms                           |
| 1425   | 60mV              | 00                   | 10ms                           |
| 1475   |                   | 01                   | 20ms                           |
| 1525   |                   | 10                   | 30ms                           |
| 1575   |                   | 11                   | 40ms                           |

Table 5. Quick Response Threshold for VDDNB Controller

| SET2 Pin Voltage Difference $\Delta V_{SET2}$<br>(Before and After Current Injection) (mV) | OFSENABLE | OFSAENABLE | QRTH [2:0] | QRTHA (for VDDNB) |
|--|-----------|------------|------------|-------------------|
| 19   | 0         | 0          | 000        | Disable           |
| 72   |           |            | 001        | 35mV              |
| 122  |           |            | 010        | 39mV              |
| 172  |           |            | 011        | 43mV              |
| 222  |           |            | 100        | 47mV              |
| 272  |           |            | 101        | 51mV              |
| 323  |           |            | 110        | 55mV              |
| 373  |           |            | 111        | 59mV              |
| 423  |           | 1          | 000        | Disable           |
| 473  |           |            | 001        | 35mV              |
| 523  |           |            | 010        | 39mV              |
| 573  |           |            | 011        | 43mV              |
| 623  |           |            | 100        | 47mV              |
| 673  |           |            | 101        | 51mV              |
| 723  |           |            | 110        | 55mV              |
| 773  |           |            | 111        | 59mV              |
| 823  | 1         | 0          | 000        | Disable           |
| 874  |           |            | 001        | 35mV              |
| 924  |           |            | 010        | 39mV              |
| 974  |           |            | 011        | 43mV              |
| 1024   |           |            | 100        | 47mV              |
| 1074   |           |            | 101        | 51mV              |
| 1124   |           |            | 110        | 55mV              |
| 1174   |           |            | 111        | 59mV              |
| 1224   |           | 1          | 000        | Disable           |
| 1274   |           |            | 001        | 35mV              |
| 1324   |           |            | 010        | 39mV              |
| 1375   |           |            | 011        | 43mV              |
| 1425   |           |            | 100        | 47mV              |
| 1475   |           |            | 101        | 51mV              |
| 1525   |           |            | 110        | 55mV              |
| 1575   |           |            | 111        | 59mV              |

**Absolute Maximum Ratings** (Note 1)

- VCC to GND ----- -0.3V to 6.5V
- RGND to GND ----- -0.3V to 0.3V
- TONSET to GND ----- -0.3V to 28V
- Other Pins ----- -0.3V to (V<sub>CC</sub> + 0.3V)
- Power Dissipation, P<sub>D</sub> @ T<sub>A</sub> = 25°C  
 WQFN-52L 6x6 ----- 3.77W
- Package Thermal Resistance (Note 2)  
 WQFN-52L 6x6, θ<sub>JA</sub> ----- 26.5°C/W  
 WQFN-52L 6x6, θ<sub>JC</sub> ----- 6.5°C/W
- Junction Temperature ----- 150°C
- Lead Temperature (Soldering, 10 sec.) ----- 260°C
- Storage Temperature Range ----- -65°C to 150°C
- ESD Susceptibility (Note 3)  
 HBM (Human Body Model) ----- 2kV

**Recommended Operating Conditions** (Note 4)

- Supply Voltage, VCC ----- 4.5V to 5.5V
- Junction Temperature Range ----- -40°C to 125°C
- Ambient Temperature Range ----- -40°C to 85°C

**Electrical Characteristics**

(V<sub>CC</sub> = 5V, T<sub>A</sub> = 25°C, unless otherwise specified)

| Parameter                 | Symbol               | Test Conditions  | Min  | Typ | Max | Unit  |
|---------------------------|----------------------|--|------|-----|-----|-------|
| <b>Input Power Supply</b> |                      |  |      |     |     |       |
| Supply Current            | I <sub>VCC</sub>     | V <sub>EN</sub> = 3V, Not Switching                      | --   | --  | 12  | mA    |
| Shutdown Current          | I <sub>SHDN</sub>    | V <sub>EN</sub> = 0V                                     | --   | --  | 5   | μA    |
| <b>Reference and DAC</b>  |                      |  |      |     |     |       |
| DC Accuracy               | V <sub>FB</sub>      | V <sub>FB</sub> = 1.0000 – 1.5500<br>(No Load, CCM Mode) | -0.5 | 0   | 0.5 | %SVID |
|                           |                      | V <sub>FB</sub> = 0.8000 – 1.0000                        | -5   | 0   | 5   | mV    |
|                           |                      | V <sub>FB</sub> = 0.3000 – 0.8000                        | -8   | 0   | 8   |       |
|                           |                      | V <sub>FB</sub> = 0.2500 – 0.3000                        | -80  | 0   | 80  |       |
| <b>RGND Current</b>       |                      |  |      |     |     |       |
| RGND Current              | I <sub>RGND</sub>    | V <sub>EN</sub> = 3V, Not Switching                      | --   | --  | 200 | μA    |
| <b>Slew Rate</b>          |                      |  |      |     |     |       |
| Dynamic VID Slew Rate     | SR                   | Set VID Fast   | 7.5  | 12  | --  | mV/μs |
| <b>Error Amplifier</b>    |                      |  |      |     |     |       |
| Input Offset              | V <sub>EA OFS</sub>  |  | --   | --  | 2   | mV    |
| DC Gain                   | ADC                  | R <sub>L</sub> = 47kΩ                                    | 70   | 80  | --  | dB    |
| Gain-Bandwidth Product    | GBW                  | C <sub>LOAD</sub> = 5pF                                  | --   | 10  | --  | MHz   |
| Output Voltage Range      | V <sub>COMP</sub>    |  | 0.3  | --  | 3.6 | V     |
| Maximum Source Current    | I <sub>EA, SRC</sub> |  | 1    | --  | --  | mA    |
| Maximum Sink Current      | I <sub>EA, SNK</sub> |  | 1    | --  | --  | mA    |

| Parameter                                   | Symbol                         | Test Conditions                                  | Min  | Typ  | Max  | Unit |
|---|--------------------------------|--|------|------|------|------|
| <b>Current Sense Amplifier</b>              |                                |  |      |      |      |      |
| Input Offset Voltage                        | V <sub>OCS</sub>               |  | -0.2 | --   | 0.2  | mV   |
| Current Mirror Gain for CORE                | A <sub>MIRROR, VDD</sub>       |  | 97   | --   | 103  | %    |
| Current Mirror Gain for NB                  | A <sub>MIRROR, VDDNB</sub>     |  | 194  | --   | 206  | %    |
| Impedance at Negative Input                 | R <sub>ISEN<sub>x</sub>N</sub> |  | 1    | --   | --   | MΩ   |
| Impedance at Positive Input                 | R <sub>ISEN<sub>x</sub>P</sub> |  | 1    | --   | --   | MΩ   |
| Internal Sum Current Sense DC Gain for CORE | A <sub>i</sub> , VDD           | VDD Controller                                   | --   | 0.4  | --   | V/V  |
| Internal Sum Current Sense DC Gain for NB   | A <sub>i</sub> , VDDNB         | VDDNB Controller                                 | --   | 0.8  | --   | V/V  |
| Maximum Source Current                      | I <sub>CS, SRC</sub>           | 0 < V <sub>FB</sub> < 2.35                       | 100  | --   | --   | μA   |
| Maximum Sink Current                        | I <sub>CS, SNK</sub>           | 0 < V <sub>FB</sub> < 2.35                       | 12   | --   | --   | μA   |
| <b>Zero Current Detection</b>               |                                |  |      |      |      |      |
| Zero Current Detection Threshold            | V <sub>ZCD_TH</sub>            | V <sub>ZCD_TH</sub> = GND - V <sub>PHASEx</sub>  | --   | 1    | --   | mV   |
| <b>Ton Setting</b>                          |                                |  |      |      |      |      |
| TONSETx Pin Minimum Voltage                 | V <sub>TON, MIN</sub>          |  | --   | 0.5  | --   | V    |
| TONSETx Ton                                 | T <sub>ON</sub>                | I <sub>RTON</sub> = 80μA, V <sub>FB</sub> = 1.1V | 270  | 305  | 340  | ns   |
| TONSETx Input Current Range                 | I <sub>RTON</sub>              | V <sub>FB</sub> = 1.1V                           | 25   | --   | 280  | μA   |
| Minimum TOFF                                | T <sub>OFF</sub>               |  | --   | 250  | --   | ns   |
| <b>IBIAS</b>                                |                                |  |      |      |      |      |
| IBIAS Pin Voltage                           | V <sub>IBIAS</sub>             | R <sub>IBIAS</sub> = 100k                        | 1.97 | 2    | 2.03 | V    |
| <b>V064</b>                                 |                                |  |      |      |      |      |
| Reference Voltage Output                    | V <sub>V064</sub>              |  | 0.61 | 0.64 | 0.67 | V    |
| Sink Current Capability                     | I <sub>V064, SNK</sub>         | V <sub>V064</sub> = 0.64V                        | 800  | --   | --   | μA   |
| Source Current Capability                   | I <sub>V064, SRC</sub>         |  | --   | --   | 100  | μA   |
| <b>Board OFSx</b>                           |                                |  |      |      |      |      |
| VFB Limit                                   | V <sub>FB, LIMIT</sub>         |  | 0    | --   | 2.35 | V    |
| OFS Update Rate                             | F <sub>OFS</sub>               |  | --   | 50   | --   | kHz  |
| Board Offset Resolution                     | ΔV <sub>OFS</sub>              |  | --   | 6.25 | --   | mV   |
| <b>Logic Inputs</b>                         |                                |  |      |      |      |      |
| EN Input Voltage                            | Logic-High                     | V <sub>IH_EN</sub>                               | 2    | --   | --   | V    |
|   | Logic-Low                      | V <sub>IL_EN</sub>                               | --   | --   | 0.8  |      |
| Leakage Current of EN                       | I <sub>LEK_EN</sub>            |  | -1   | --   | 1    | μA   |
| SVC, SVD, SVT, PWROK                        | Logic-High                     | V <sub>IH_SVI</sub>                              | 70   | --   | 100  | %    |
|   | Logic-Low                      | V <sub>IL_SVI</sub>                              | 0    | --   | 35   |      |
| Hysteresis of SVC, SVD, SVT, PWROK          | V <sub>HYS_SVI</sub>           | Respect to VDDIO                                 | 10   | --   | --   | %    |

| Parameter                             | Symbol   | Test Conditions   | Min  | Typ  | Max  | Unit               |
|---------------------------------------|--|---|------|------|------|--------------------|
| <b>Protection</b>                     |  |   |      |      |      |                    |
| Under Voltage Lockout Threshold       | V <sub>UVLO</sub>                              | V <sub>CC</sub> Falling edge                                      | 4    | 4.2  | 4.4  | V                  |
| Under Voltage Lockout Hysteresis      | ΔV <sub>UVLO</sub>                             |   | --   | 100  | --   | mV                 |
| Under Voltage Lockout Delay           | T <sub>UVLO</sub>                              | V <sub>CC</sub> Rising above UVLO Threshold                       | --   | 3    | --   | μs                 |
| Over Voltage Protection Threshold     | V <sub>OVP</sub>                               |   | 275  | 325  | 375  | mV                 |
| Over Voltage Protection Delay         | T <sub>OVP</sub>                               | V <sub>SEN</sub> Rising above Threshold                           | --   | 1    | --   | μs                 |
| Under Voltage Protection Threshold    | V <sub>UVP</sub>                               |   | -375 | -325 | -275 | mV                 |
| Under Voltage Protection Delay        | T <sub>UVP</sub>                               | V <sub>SEN</sub> Falling below Threshold                          | --   | 3    | --   | μs                 |
| Negative Voltage Protection Threshold | V <sub>NV</sub>                                |   | --   | 0    | --   | mV                 |
| Per Phase OCP Threshold               | I <sub>OCP_PERPHASE</sub>                      | I <sub>ISEN</sub> xN Per-Phase OCP Threshold.                     | --   | 10   | --   | μA                 |
| Delay of Per Phase OCP                | T <sub>PHOCP</sub>                             |   | --   | 1    | --   | μs                 |
| OCP_SPIKE Threshold                   | I <sub>OCP_SPIKE</sub>                         | DCR = 0.95mΩ, R <sub>SENSE</sub> = 680Ω, R <sub>IMON</sub> = 10kΩ | 162  | 180  | 198  | A                  |
| OCP_SPIKE Action Delay                | T <sub>OCPSPIKE_ACTION_DLY</sub>               |   | 6    | --   | 12   | μs                 |
| OCP_TDC Action Delay                  | T <sub>OCP_TDC_ACTION_DLY</sub>                |   | 12   | --   | 24   | μs                 |
| <b>OCP_L, PGOOD and PGOODA</b>        |  |   |      |      |      |                    |
| Output Low Voltage at OCP_L           | V <sub>OCP_L</sub>                             | I <sub>OCP_L</sub> = 4mA  | 0    | --   | 0.2  | V                  |
| OCP_L Assertion Time                  | T <sub>OCP_L</sub>                             |   | 2    | --   | --   | μs                 |
| Output Low Voltage at PGOOD, PGOODA   | V <sub>PGOOD</sub> , V <sub>PGOODA</sub>       | I <sub>PGOOD</sub> = 4mA, I <sub>PGOODA</sub> = 4mA               | 0    | --   | 0.2  | V                  |
| PGOOD and PGOODA Threshold Voltage    | V <sub>TH_PGOOD</sub> , V <sub>TH_PGOODA</sub> | Respect to V <sub>BOOT</sub>                                      | --   | -300 | --   | mV                 |
| PGOOD and PGOODA Delay Time           | T <sub>PGOOD</sub> , T <sub>PGOODA</sub>       | V <sub>SEN</sub> = V <sub>BOOT</sub> to PGOOD/PGOODA High         | 70   | 100  | 130  | μs                 |
| <b>Current Report</b>                 |  |   |      |      |      |                    |
| Maximum Reported Current (FFh = OCP)  |  |   | --   | 100  | --   | %IDD_SP<br>IKE_OCP |
| Minimum Reported Current (00h)        |  |   | --   | 0    | --   | %IDD_SP<br>IKE_OCP |
| IDD Spike Current Accuracy            |  |   | --   | --   | 3    | %                  |

| Parameter  | Symbol                  | Test Conditions     | Min | Typ  | Max | Unit |
|--|-------------------------|---------------------|-----|------|-----|------|
| <b>Voltage Report</b>  |                         |                     |     |      |     |      |
| Maximum Reported Voltage (0_00h)                             |                         |                     | --  | 3.15 | --  | V    |
| Minimum Reported Voltage (1_F8h)                             |                         |                     | --  | 0    | --  | V    |
| Voltage Accuracy   |                         |                     | -2  | --   | 2   | LSB  |
| <b>QR Setting of VDD and VDDNB</b>                           |                         |                     |     |      |     |      |
| Quick Response Threshold Voltage Setting Range Minimum Value | V <sub>QRTH, MINx</sub> | QRTHx [2:0] = [001] | --  | 35   | --  | mV   |
| Quick Response Threshold Voltage Setting Range Maximum Value | V <sub>QRTH, MAXx</sub> | QRTHx [2:0] = [111] | --  | 60   | --  | mV   |
| <b>PWM Driving Capability</b>                                |                         |                     |     |      |     |      |
| PWMx Source Resistance                                       | R <sub>PWM_SRC</sub>    |                     | --  | 20   | --  | Ω    |
| PWMx Sink Resistance   | R <sub>PWM_SNK</sub>    |                     | --  | 10   | --  | Ω    |
| <b>SVI2 Bus</b>  |                         |                     |     |      |     |      |
| SVC Frequency  | f <sub>SVC</sub>        | (Note 5)            | 0.1 | --   | 30  | MHz  |

- Note 1.** Stresses beyond those listed “Absolute Maximum Ratings” may cause permanent damage to the device. These are stress ratings only, and functional operation of the device at these or any other conditions beyond those indicated in the operational sections of the specifications is not implied. Exposure to absolute maximum rating conditions may affect device reliability.
- Note 2.**  $\theta_{JA}$  is measured under natural convection (still air) at  $T_A = 25^\circ\text{C}$  with the component mounted on a high effective-thermal-conductivity four-layer test board on a JEDEC 51-7 thermal measurement standard.  $\theta_{JC}$  is measured at the exposed pad of the package.
- Note 3.** Devices are ESD sensitive. Handling precaution is recommended.
- Note 4.** The device is not guaranteed to function outside its operating conditions.
- Note 5.** Min. SVC frequency defined in electrical spec. is related with different application. As min. SVC < 1MHz, VR can't support telemetry reporting function. As min. SVC < 400kHz, VR can't support telemetry reporting function and VOTF complete function.



Typical Application Circuit

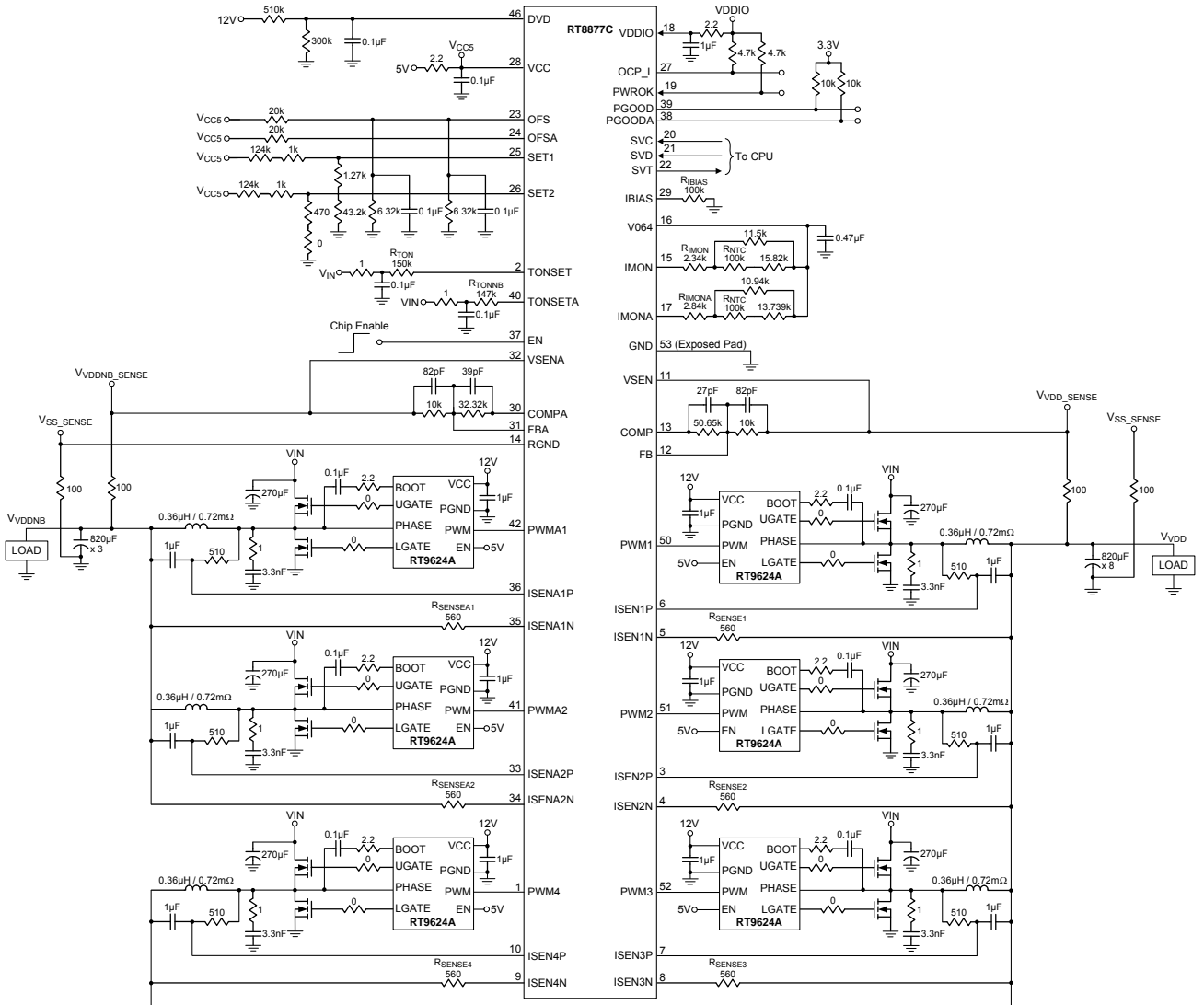

Typical Operating Characteristics

CORE VR Power On from EN

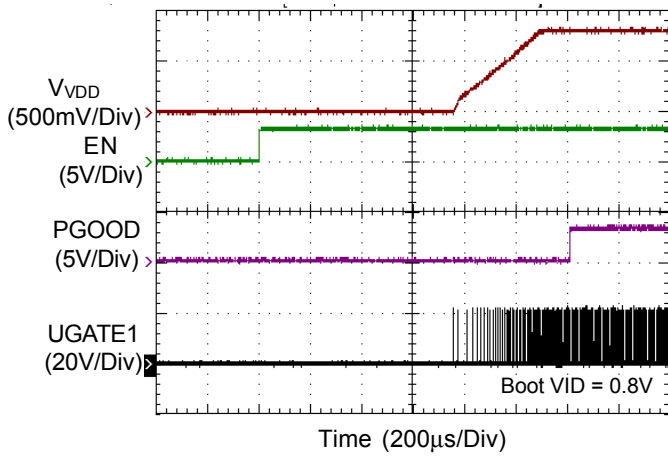

CORE VR Power Off from EN

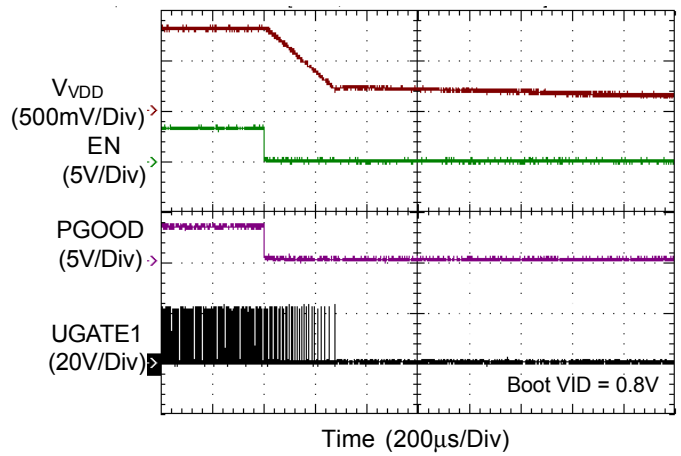

CORE VR OCP\_TDC

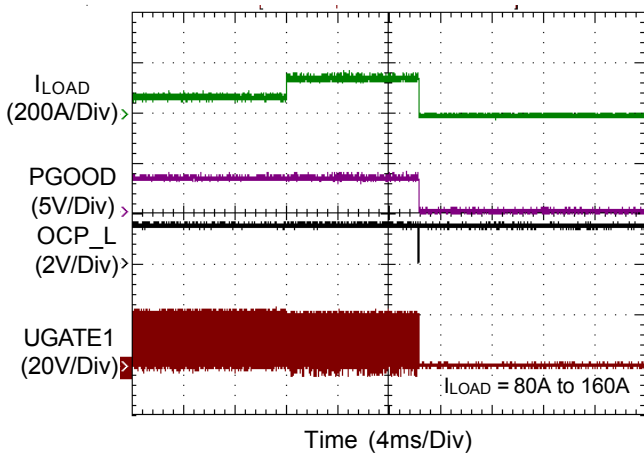

CORE VR OCP\_SPIKE

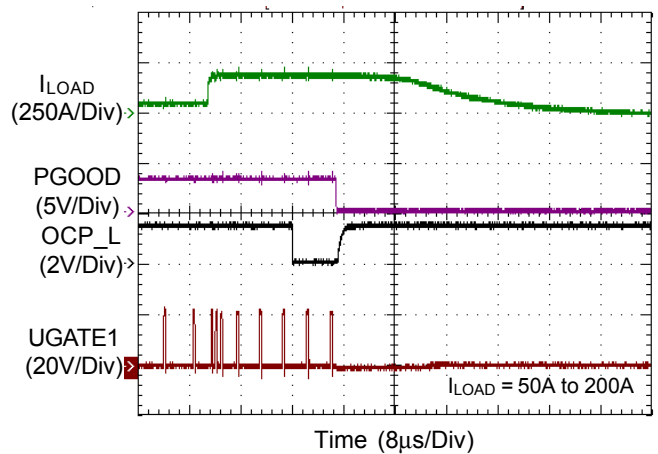

CORE VR OVP and NVP

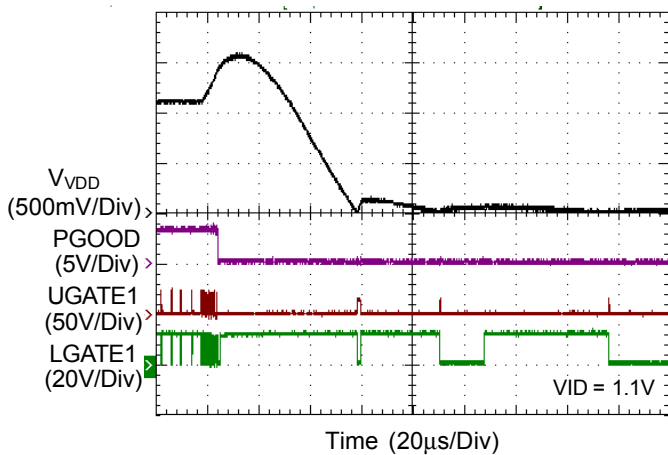

CORE VR UVP

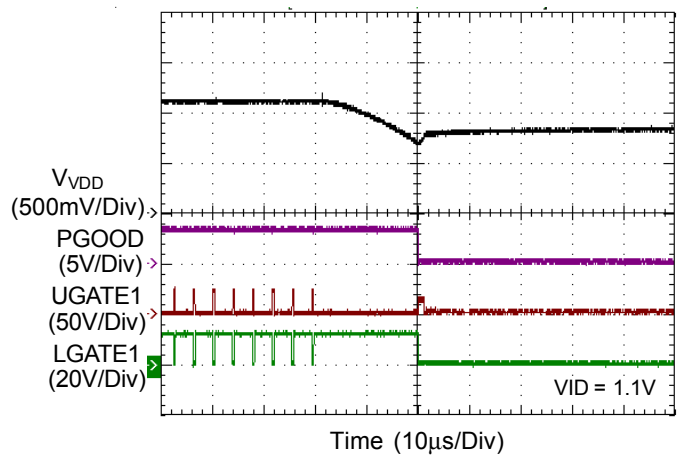

**CORE VR Dynamic VID Up**

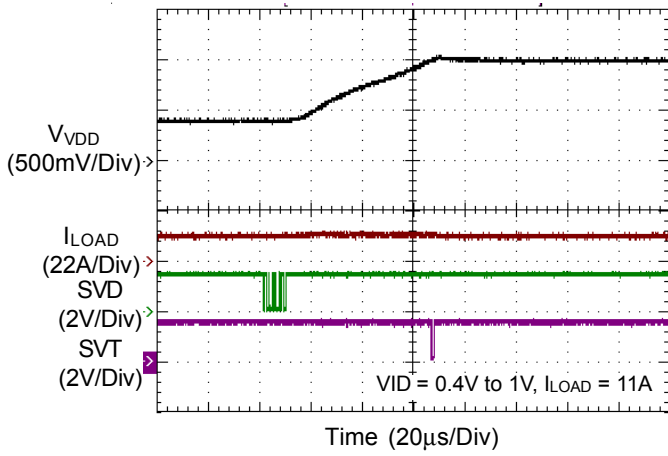

**CORE VR Dynamic VID Up**

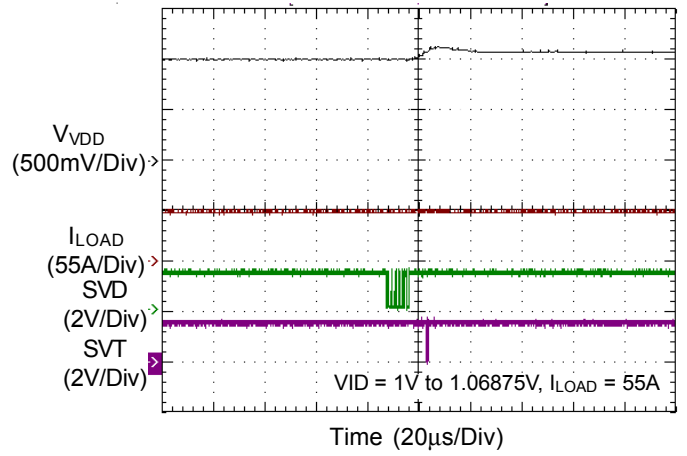

**CORE VR Dynamic VID Up**

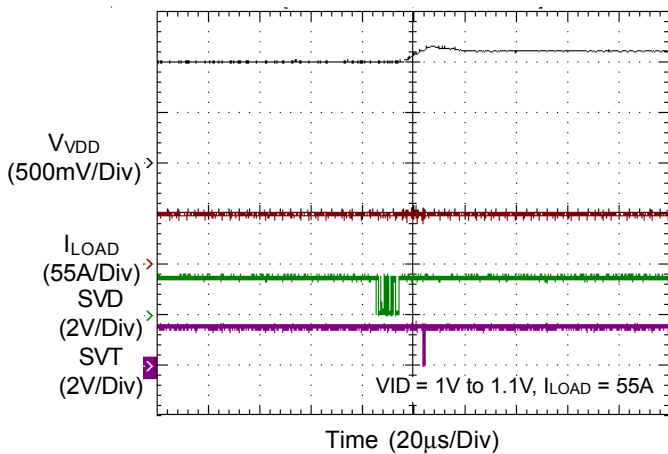

**CORE VR Dynamic VID Up**

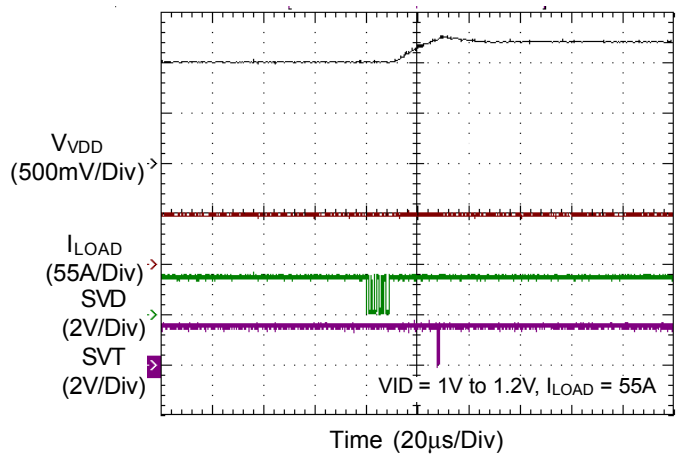

**CORE VR Dynamic VID Up**

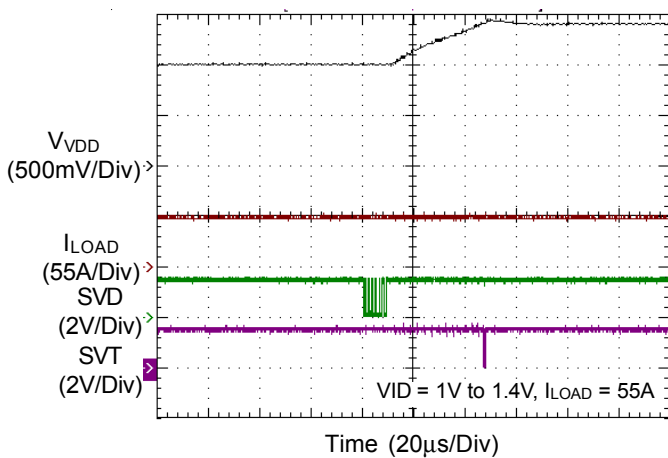

**CORE VR Load Transient**

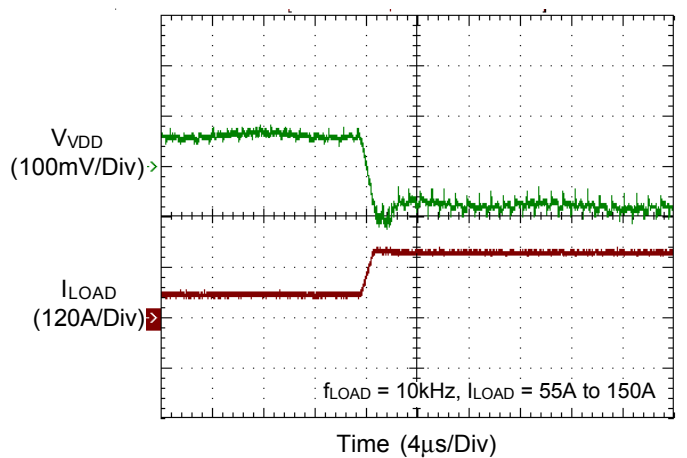

CORE VR Load Transient

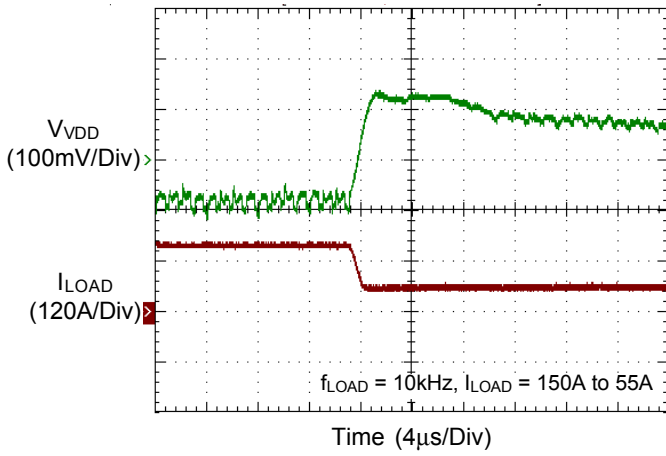

NB VR Power On from EN

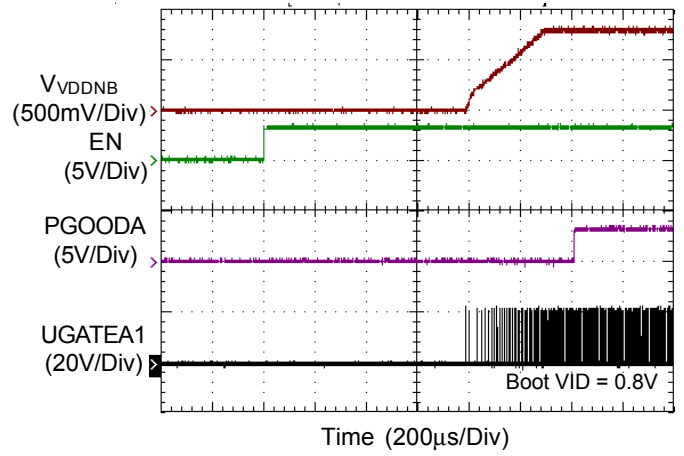

NB VR Power Off from EN

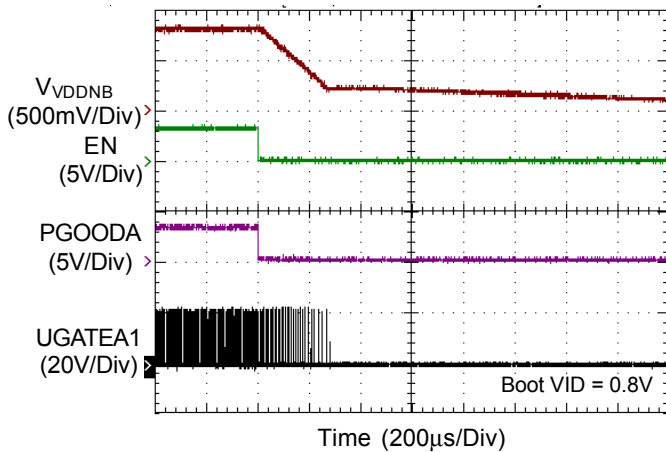

NB VR OCP\_TDC

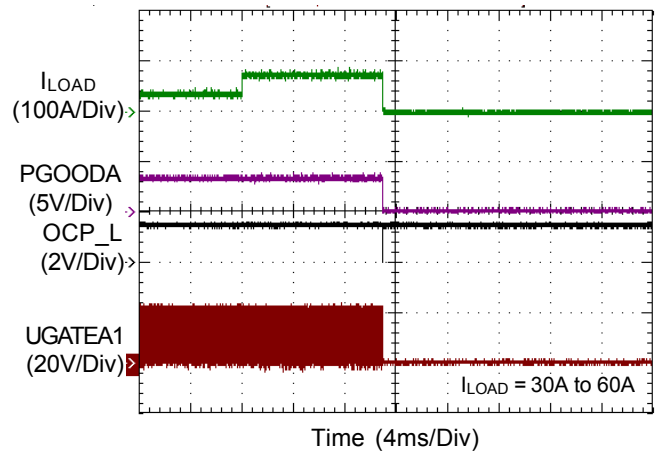

NB VR OCP\_SPIKE

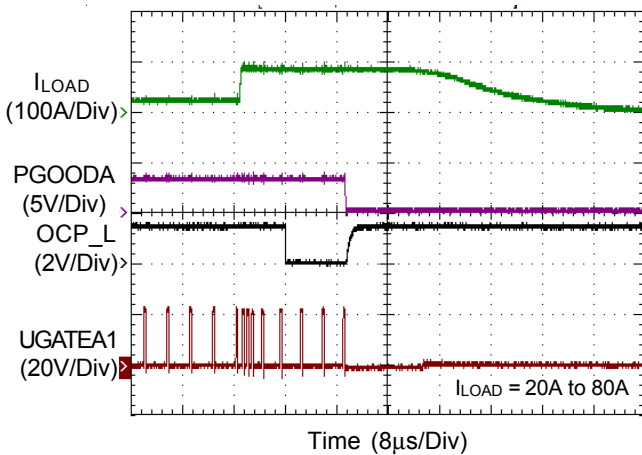

NB VR OVP and NVP

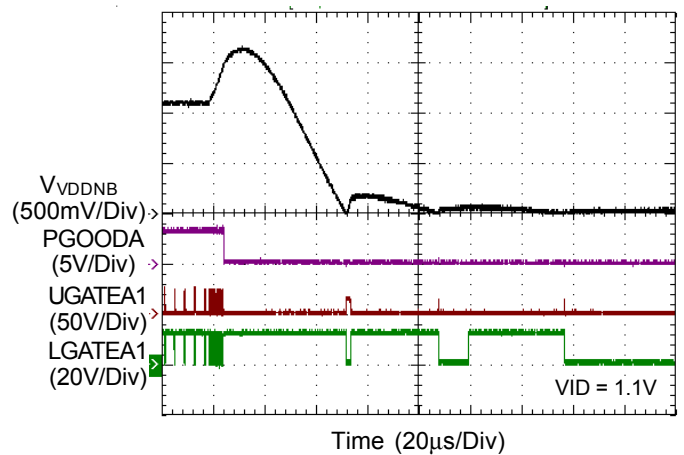

**NB VR UVP**

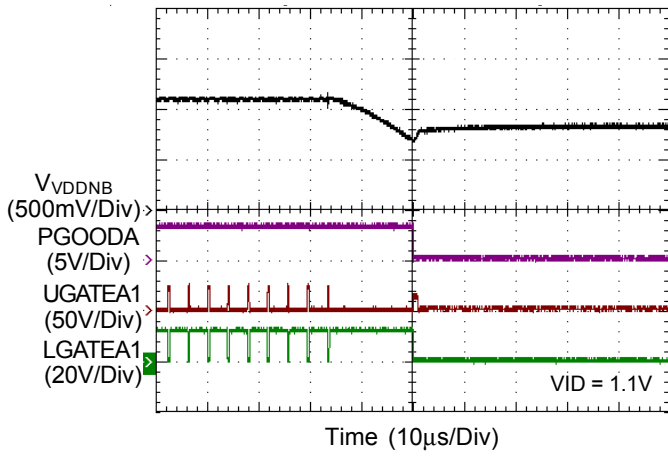

**NB VR Dynamic VID Up**

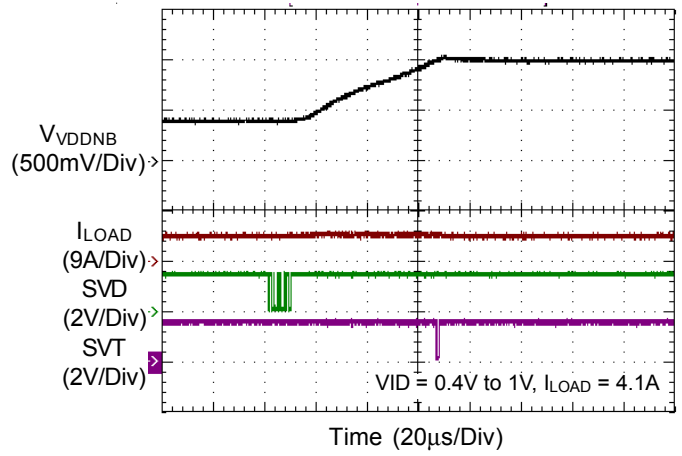

**NB VR Dynamic VID Up**

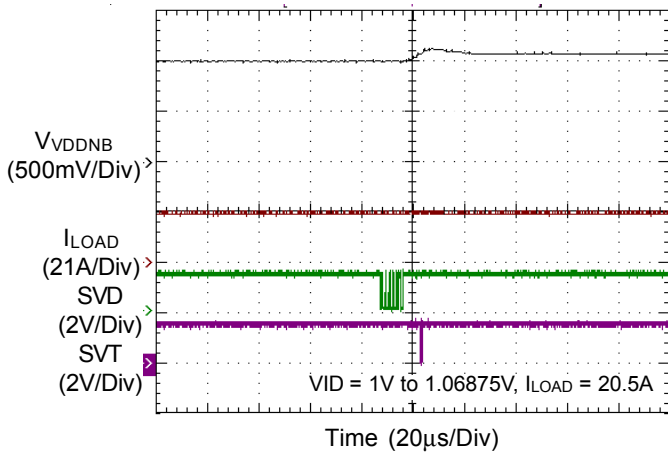

**NB VR Dynamic VID Up**

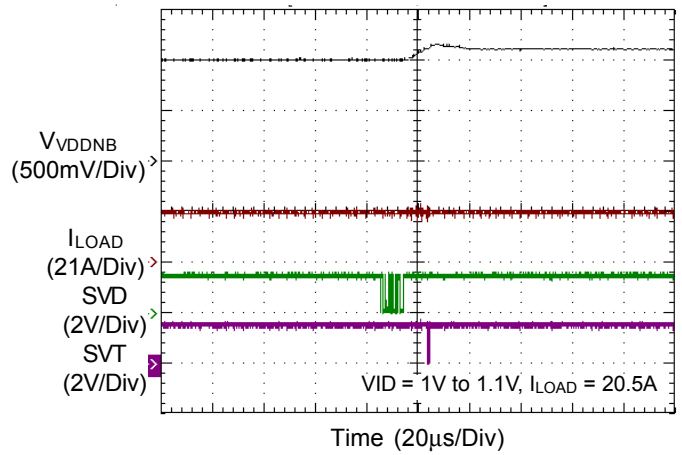

**NB VR Dynamic VID Up**

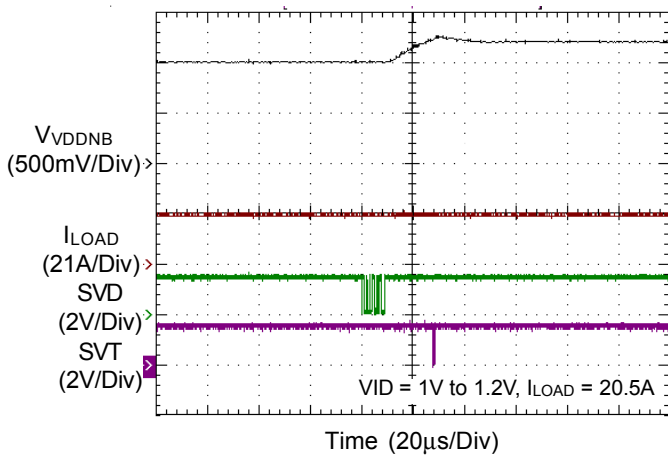

**NB VR Dynamic VID Up**

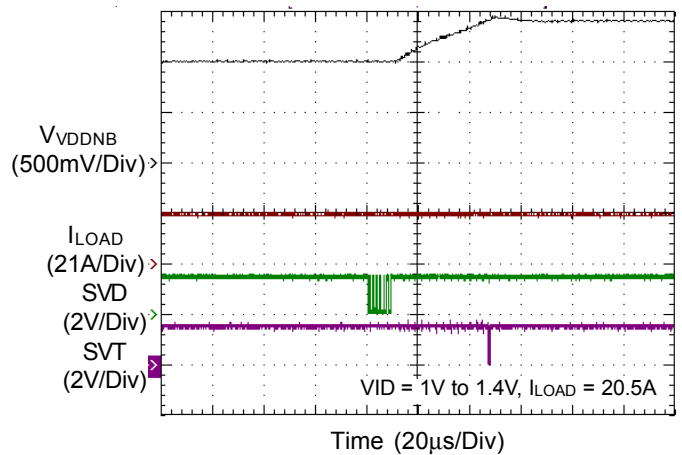

NB VR Load Transient

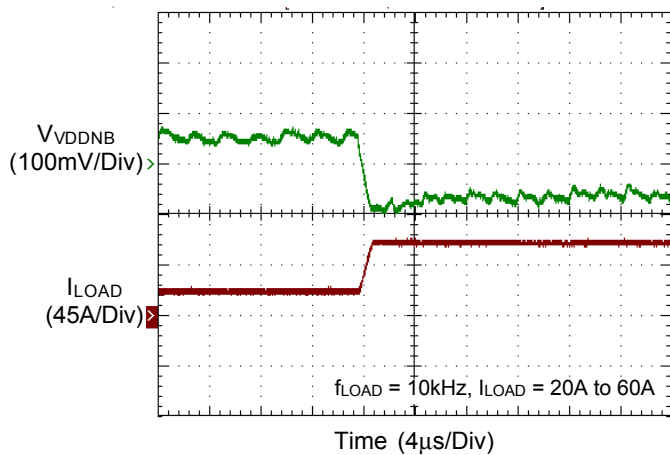

NB VR Load Transient

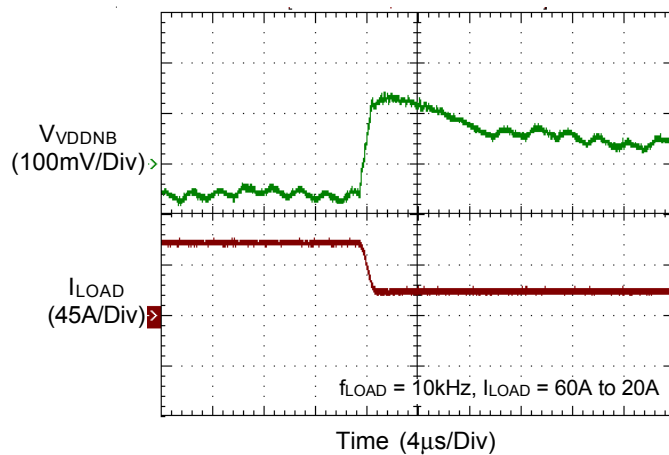

## Application Information

### Power Ready (POR) Detection

During start-up, the RT8877C will detect the voltage at the voltage input pins : VCC, EN and DVD. When  $V_{CC} > 4.2V$  and  $V_{DVD} > 2.2V$ , the IC will recognize the power state of system to be ready (POR = high) and wait for enable command at the EN pin. After POR = high and  $V_{EN} > 2V$ , the IC will enter start-up sequence for both VDD rail and VDDNB rail. If the voltage at any voltage input pin drops below low threshold (POR = low), the IC will enter power down sequence and all the functions will be disabled. Normally, connecting system power to the EN pin and power stage VIN (12V, through a voltage divider) to the DVD pin is recommended. The SVID will be ready in 2ms (max) after the chip has been enabled. All the protection latches (OVP, OCP, UVP) will be cleared only after POR = low. The condition of  $V_{EN} = \text{low}$  will not clear these latches. While VDD and VDDNB regulate, DVD falls lower than 1.5V. Then IC will shut down immediately until POR recycle.

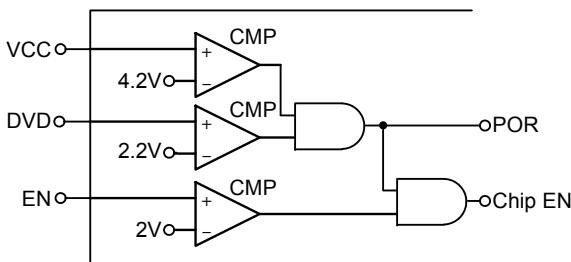

Figure 1. Power Ready (POR) Detection

### Precise Reference Current Generation

The RT8877C includes complicated analog circuits inside the controller. The IC needs very precise reference voltage/current to drive these analog circuits. The IC will auto generate a 2V voltage source at IBIAS pin, and a 100kΩ resistor is required to be connected between IBIAS and analog ground, as shown in Figure 2. Through this connection, the IC will generate a 20μA current from the IBIAS pin to analog ground, and this 20μA current will be mirrored for internal use. Note that other type of connection or other values of resistance applied at the IBIAS pin may cause functional failure, such as slew rate control, OFS

accuracy, etc. In other words, the IBIAS pin can only be connected with a 100kΩ resistor to GND. The resistance accuracy of this resistor is recommended to be 1% or higher.

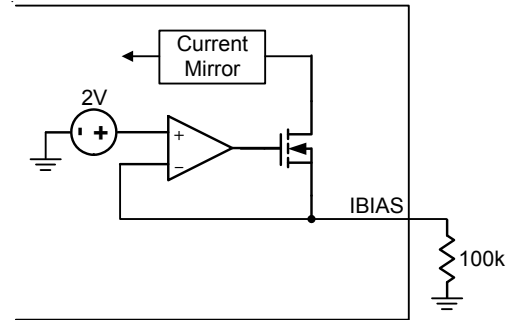

Figure 2. IBIAS Setting

### Boot VID

When EN goes high, both VDD and VDDNB output begin to soft-start to the boot VID in CCM. Table 6 shows the Boot VID setting. The Boot VID is determined by the SVC and SVD input states at EN rising edge and it is stored in the internal register. The digital soft-start circuit ramps up the reference voltage at a controlled slew rate to reduce inrush current during start up. When all the output voltages are above power good threshold (300mV below Boot VID) at the end of soft-start, the controller asserts power good after a time delay.

Table 6. 2-Bit Boot VID Code

| Initial Startup VID (Boot VID) |     |                              |
|--------------------------------|-----|------------------------------|
| SVC                            | SVD | VDD/VDDNB Output Voltage (V) |
| 0                              | 0   | 1.1                          |
| 0                              | 1   | 1.0                          |
| 1                              | 0   | 0.9                          |
| 1                              | 1   | 0.8                          |

### Start-Up Sequence

After EN goes high, the RT8877C starts up and operates according to the initial settings. Figure 3 shows the simplified sequence timing diagram. The detailed operation is described in the following.

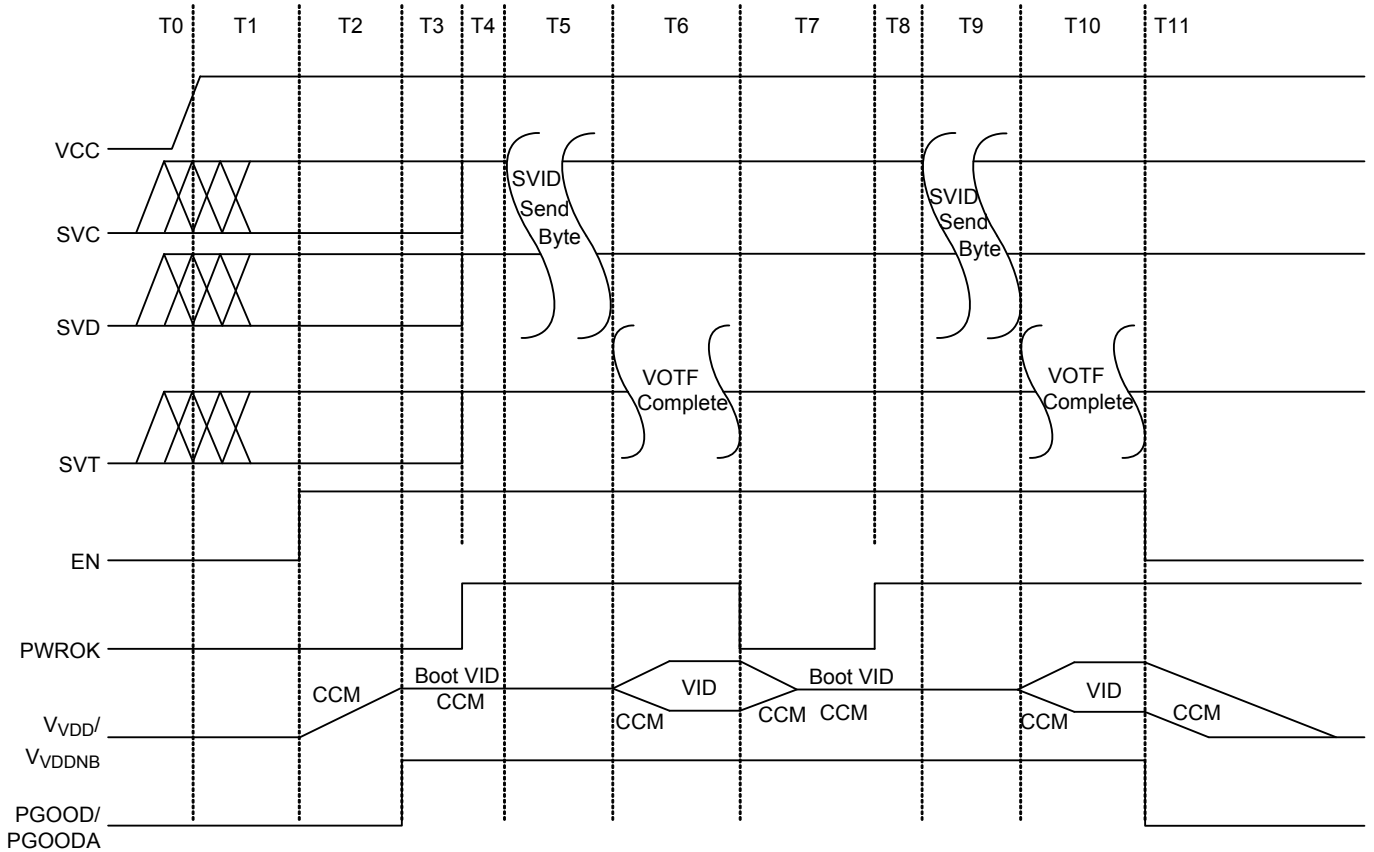

Figure 3. Simplified Sequence Timing Diagram

Description of Figure 3 :

T0 : The RT8877C waits for VCC POR.

T1 : The SVC pin and SVD pin set the Boot VID. Boot VID is latched at EN rising edge. SVT is driven high by the RT8877C.

T2 : The enable signal goes high and all output voltages ramp up to the Boot VID in CCM. The soft-start slew rate is 3mV/μs.

T3 : All output voltages are within the regulation limits and the PGOOD and PGOODA signal goes high.

T4 : The PWROK pin goes high and the SVI2 interface starts running. The RT8877C waits for SVID command from processor.

T5 : A valid SVID command transaction occurs between the processor and the RT8877C.

T6 : The RT8877C starts VOTF (VID-on-the-fly) transition according to the received SVID command and send a VOTF Complete if the VID reaches target VID.

T7 : The PWROK pin goes low and the SVI2 interface stops running. All output voltages go back to the boot VID in CCM.

T8 : The PWROK pin goes high again and the SVI2 interface starts running. The RT8877C waits for SVID command from processor.

T9 : A valid SVID command transaction occurs between the processor and the RT8877C.

T10 : The RT8877C starts VID-on-the-fly transition according to the received SVID command and send a VOTF Complete if the VID reaches target VID.

T11 : The enable signal goes low and all output voltages enter soft-shutdown mode.



**Power Down Sequence**

If the voltage at EN pin falls below the enable falling threshold, the controller is disabled. The voltage at the PGOOD and PGOODA pin will immediately go low at the loss of enable signal at the EN pin and the controller executes soft-shutdown operation. The internal digital circuit ramps down the reference voltage at the same slew rate as that of in soft-start, making VDD and VDDNB output voltages gradually decrease in CCM. Each of the controller channels stops switching when the voltage at the voltage sense pin  $V_{SEN}/V_{SENA}$ , cross about 0.2V. The Boot VID information stored in the internal register is cleared at POR. This event forces the RT8877C to check the SVC and SVD inputs for a new boot VID when the EN voltage goes high again.

**PGOOD and PGOODA**

The PGOOD and PGOODA are open-drain logic outputs. The 2 pins provide the power good signal when VDD and VDDNB output voltage are within the regulation limits and no protection is triggered. These pins are typically tied to 3.3V or 5V power source through a pull-high resistor. During shutdown state (EN = low) and the soft-start period, the PGOOD and PGOODA voltages are pulled low. After a successful soft-start and VDD and VDDNB output voltages are within the regulation limits, the PGOOD and PGOODA are released high individually.

The voltages at the PGOOD pin and PGOODA pin are pulled low individually during normal operation when any of the following events occurs: over voltage protection, under voltage protection, over current protection, and logic low EN voltage. If one rail triggers protection, another rail's PGOOD will be pull low after 5 $\mu$ s delay.

**SVI2 Wire Protocol**

The RT8877C complies with AMD's Voltage Regulator Specification, which defines the Serial VID Interface 2 (SVI2) protocol. With SVI2 protocol, the processor directly controls the reference voltage level of each individual controller channel and determines which controller operates in power saving mode. The SVI2 interface is a three wire bus that connects a single master to one or above slaves. The master initiates and terminates SVI2 transactions and drives the clock, SVC, and the data, SVD, during a transaction. The slave drives the telemetry, SVT during a transaction. The AMD processor is always the master. The voltage regulator controller (RT8877C) is always the slave. The RT8877C receives the SVID code and acts accordingly. The SVI protocol supports 20MHz high speed mode I<sup>2</sup>C, which is based on SVD data packet. Table 7 shows the SVD data packet. A SVD packet consists of a "Start" signal, three data bytes after each byte, and a "Stop" signal. The 8-bit serial VID codes are listed in Table1. After the RT8877C has received the stop sequence, it decodes the received serial VID code and executes the command. The controller has the ability to sample and report voltage and current for the VDD and VDDNB domains. The controller reports this telemetry serially over the SVT wire which is clocked by the processor driven SVC. A bit TFN at SVD packet along with the VDD and VDDNB domain selector bits are used by the processor to change the telemetry functionality. The telemetry bit definition is listed in Figure 4. The detailed SVI2 specification is outlined in the AMD Voltage Regulator and Voltage Regulator Module (VRM) and Serial VID Interface 2.0 (SVI2) Specification.

**Table 7. SVD Data Packet**

| Bit Time | Description   |
|----------|---|
| 1 : 5    | Always 11000b   |
| 6        | VDD domain selector bit, if set then the following two data bytes contain the VID for VDD, the PSI state for VDD, and the load line slope trim and offset trim state for VDD.         |
| 7        | VDDNB domain selector bit, if set then the following two data bytes contain the VID for VDDNB, the PSI state for VDDNB, and the load line slope trim and offset trim state for VDDNB. |
| 8        | Always 0b   |
| 10       | PSIO_L  |
| 11 : 17  | VID Code bits [7:1]   |
| 19       | VID Code bit [0]  |

| Bit Time | Description                   |
|----------|-------------------------------|
| 20       | PSI1_L                        |
| 21       | TFN (Telemetry Functionality) |
| 22 : 24  | Load Line Slope Trim [2:0]    |
| 25 : 26  | Offset Trim [1:0]             |

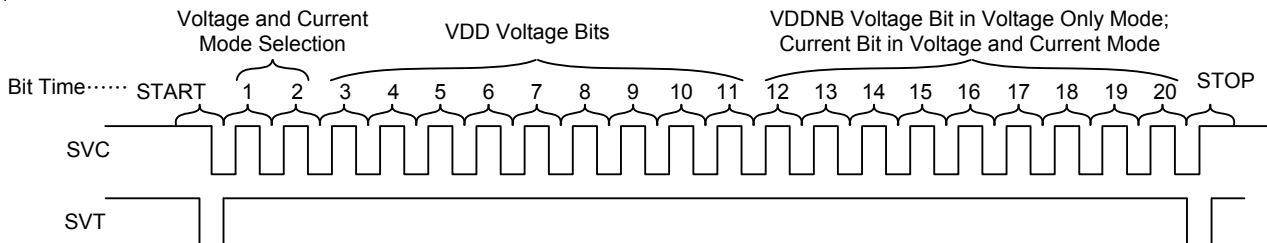

Figure 4. Telemetry Bit Definition

**PWROK and SVI2 Operation**

The PWROK pin is an input pin, which is connected to the global power good signal from the platform. Logic high at this pin enables the SVI2 interface, allowing data transaction between processor and the RT8877C. Once the RT8877C receives a valid SVID code, it decodes the information from processor to determine which output plane is going to move to the target VID. The internal DAC then steps the reference voltage in a controlled slew rate, making the output voltage shift to the required new VID. Depending on the SVID code, more than one controller channels can be targeted simultaneously in the VID transition. For example, VDD and VDDNB voltages can ramp up/down at the same time.

If the PWROK input goes low during normal operation, the SVI2 protocol stops running. The RT8877C immediately drives SVT high and modifies all output voltages back to the boot VID, which is stored in the internal register right after the controller is enabled. The controller does not read SVD and SVC inputs after the loss of PWROK. If the PWROK input goes high again, the SVI2 protocol resumes running. The RT8877C then waits to decode the SVID command from processor for a new VID and acts as previously described. The SVI2 protocol is only running when the PWROK input goes high after the voltage at the EN pin goes high; otherwise, the RT8877C will not soft-start due to incorrect signal sequence.

**VID-on-the-Fly Transition**

After the RT8877C has received a valid SVID code, it enters CCM mode and executes the VID-on-the-fly transition by stepping up/down the reference voltage of the required controller channel(s) in a controlled slew rate, hence allowing the output voltage(s) to ramp up/down to the target VID. The output voltage slew rate during the VID-on-the-fly transition is faster than that in a soft-start/soft-shutdown operation. If the new VID level is higher than the current VID level, the controller begins stepping up the reference voltage with a typical slew rate of 12.5mV/μs upward to the target VID level. If the new level is lower than the current VID level, the controller begins stepping down the reference voltage with a typical slew rate of -12.5mV/μs downward to the target VID level.

During the VID-on-the-fly transition, the RT8877C will force the controller channel to operate in CCM mode. If the controller channel operates in the power-saving mode prior to the VID-on-the-fly transition, it will be in CCM mode during the transition and then back to the power saving mode at the end of the transition. The voltage at the PGOOD pin and PGOODA pin will keep high during the VID-on-the-fly transition. The RT8877C checks the output voltage for voltage-related protections and send a VOTF complete at the end of VID-on-the-fly transition. In the event of receiving a VID off code, the RT8877C steps the reference voltage of required controller channel down to zero, hence making the required output voltage decrease to zero. The voltage at the PGOOD pin and PGOODA pin will remain high since the VID code is valid.

**Operation Mode Transition**

The RT8877C supports operation mode transition function in VDD and VDDNB controller for the PSI[x]\_L and command from AMD processor. Referring to Table 7, the PSI[x]\_L bit in the SVI2 protocol controls the operating mode of the RT8877C controller channels. The default operation mode of VDD and VDDNB controller is CCM. When the VDD controller is in full-phase configuration and receives PSI0\_L = 0 and PSI1\_L = 1, the VDD controller will keep full-phase operation. When the VDD controller receives PSI0\_L = 0 and PSI1\_L = 0, the VDD controller takes phase shedding operation and enters diode emulation mode. In reverse, the VDD controller goes back to full-phase operation in CCM upon receiving PSI0\_L = 1 and PSI1\_L = 0 or 1, or PSI0\_L = 0 and PSI1\_L = 1. When the VDDNB controller receives PSI0\_L = 0 and PSI1\_L = 1, it enters single-phase CCM, when the VDDNB controller receives PSI0\_L = 0 and PSI1\_L = 0, it enters single-phase diode emulation mode. When the VDDNB controller goes back to full-phase CCM operation after receiving PSI0\_L = 1 and PSI1\_L = 0 or 1.

**Differential Remote Sense Setting**

The VDD and VDDNB controllers have differential, remote-sense inputs to eliminate the effects of voltage drops along the PC board traces, processor internal power routes and socket contacts. The processor contains on-die sense pins, VDD\_SENSE, VDDNB\_SENSE and VSS\_SENSE. Connect RGND to VSS\_SENSE. For VDD controller, connect FB to VDD\_SENSE with a resistor to build the negative input path of the error amplifier. Connect FB\_NB to VDDNB\_SENSE with a resistor using the same way in VDD controller. Connect VSS\_SENSE to RGND using separate trace as shown in Figure 5. The precision reference voltages refer to RGND for accurate remote sensing.

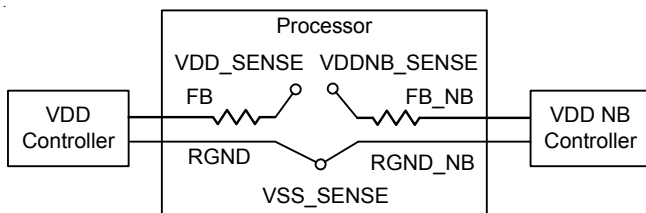

Figure 5. Differential Remote Voltage Sense Connection

**SET1 and SET2 Pin Setting**

The RT8877C provides SET1 pin for platform users to set the VDD and VDDNB controller OCP\_TDC threshold and internal ramp amplitude (RSET & RSETA), SET2 pin to set VDD and VDDNB controller OCP trigger delay (OCPTRGDELAY) and quick response threshold (QRTH & QRTHA). To set these pin, platform designers should use resistive voltage divider on these pins, refer to Figure 6 and Figure 7. The voltage at SET1 and SET2 pin is

$$V_{SET1} = VCC \times \frac{R_{OCPTDC,D}}{R_{OCPTDC,U} + R_{OCPTDC,D}} \tag{1}$$

$$V_{SET2} = VCC \times \frac{R_{QRTH,D}}{R_{QRTH,U} + R_{QRTH,D}} \tag{2}$$

The ADC monitors and decodes the voltage at this pin only once after power up. After ADC decoding (only once), a 40µA current (when VCC = 5V) will be generated at the SET1 and SET2 pin for internal use. That is the voltage at SET1 and SET2 pin is

$$\Delta V_{SET1} = 40\mu A \times \frac{R_{OCPTDC,U} \times R_{OCPTDC,D}}{R_{OCPTDC,U} + R_{OCPTDC,D}} \tag{3}$$

$$\Delta V_{SET2} = 40\mu A \times \frac{R_{QRTH,U} \times R_{QRTH,D}}{R_{QRTH,U} + R_{QRTH,D}} \tag{4}$$

From equation (1) to equation (4) and Table 2 to Table 5, platform users can set the OCP\_TDC threshold, OCP trigger delay, internal ramp amplitude and quick response threshold for VDD and VDDNB controller.

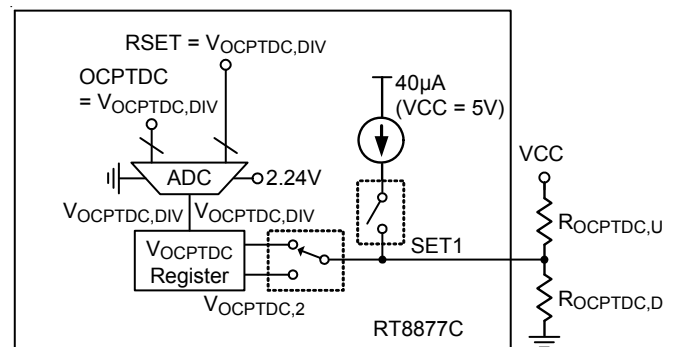

Figure 6. OCP\_TDC/RSET Setting

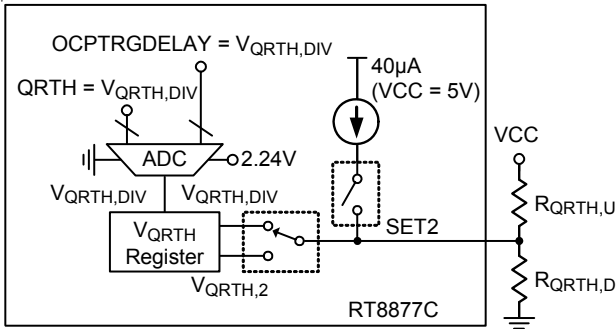

Figure 7. QRTH/OCPTRGDELAY Setting

**VDD Controller**

**Active Phase Determination : Before POR**

The number of active phases is determined by the internal circuitry that monitors the ISENxN voltages during start-up. Normally, the VDD controller operates as a 4-phase PWM controller. Pulling ISEN4N to VCC programs a 3-phase operation, pulling ISEN3N to VCC programs a 2-phase operation, and pulling ISEN2N to VCC programs a 1-phase operation. At EN rising edge, VDD controller detects whether the voltages of ISEN2N, ISEN3N and ISEN4N are higher than “VCC – 0.5V” respectively to decide how many phases should be active. Phase selection is only active during POR. When POR = high, the number of active phases is determined and latched. The unused ISENxP pins are recommended to be connected to VCC and unused PWM pins can be left floating.

**Loop Control**

The VDD controller adopts Richtek's proprietary G-NAVP™ topology. G-NAVP™ is based on the finite gain peak current mode with CCRCOT (Constant Current Ripple Constant On-Time) topology. The output voltage, V<sub>VDD</sub> will decrease with increasing output load current. The control loop consists of PWM modulators with power stages, current sense amplifiers and an error amplifier as shown in Figure 8.

Similar to the peak current mode control with finite compensator gain, the HS\_FET on-time is determined by CCRCOT on-time generator. When load current increases, V<sub>CS</sub> increases, the steady state COMP voltage also increases and induces V<sub>VDD</sub> to decrease, thus achieving

AVP. A near-DC offset canceling is added to the output of EA to eliminate the inherent output offset of finite gain peak current mode controller.

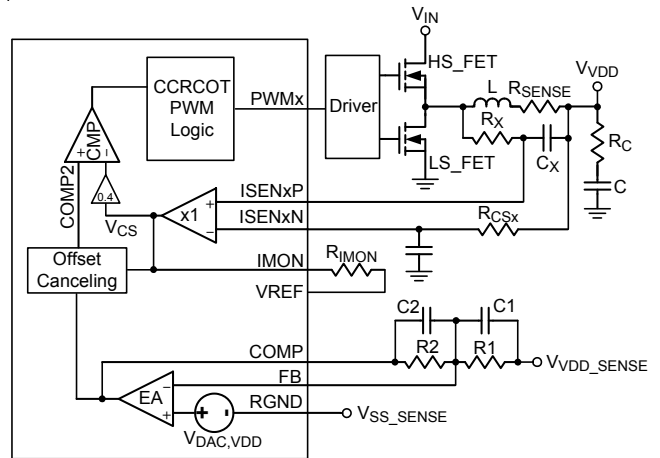

Figure 8. VDD Controller : Simplified Schematic for Droop and Remote Sense in CCM

**Droop Setting**

It's very easy to achieve Active Voltage Positioning (AVP) by properly setting the error amplifier gain due to the native droop characteristics as shown in Figure 9. This target is to have

$$V_{VDD} = V_{DAC, VDD} - I_{LOAD} \times R_{DROOP} \tag{5}$$

Then solving the switching condition  $V_{COMP2} = V_{CS}$  in Figure 8 yields the desired error amplifier gain as

$$A_V = \frac{R_2}{R_1} = \frac{G_1}{R_{DROOP}} \tag{6}$$

$$G_1 = \frac{R_{SENSE}}{R_{CSx}} \times R_{IMON} \times \frac{4}{10} \tag{7}$$

where  $G_1$  is the internal current sense amplifier gain.  $R_{SENSE}$  is the current sense resistor. If no external sense resistor present, it is the equivalent resistance of the inductor.  $R_{DROOP}$  is the equivalent load line resistance as well as the desired static output impedance.

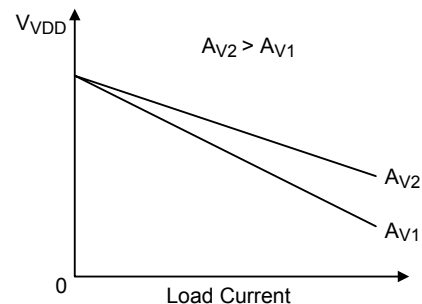

Figure 9. VDD Controller : Error Amplifier gain (AV) Influence on V<sub>VDD</sub> Accuracy

**Loop Compensation**

Optimized compensation of the VDD controller allows for best possible load step response of the regulator's output. A type-I compensator with one pole and one zero is adequate for proper compensation. Figure 10 shows the compensation circuit. Previous design procedure shows how to select the resistive feedback components for the error amplifier gain. Next, C1 and C2 must be calculated for compensation. The target is to achieve constant resistive output impedance over the widest possible frequency range.

The pole frequency of the compensator must be set to compensate the output capacitor ESR zero :

$$f_p = \frac{1}{2\pi \times C \times R_C} \tag{8}$$

Where C is the capacitance of output capacitor, and R<sub>C</sub> is the ESR of output capacitor. C2 can be calculated as follows :

$$C2 = \frac{C \times R_C}{R2} \tag{9}$$

The zero of compensator has to be placed at half of the switching frequency to filter the switching related noise. Such that,

$$C1 = \frac{1}{R1 \times \pi \times f_{SW}} \tag{10}$$

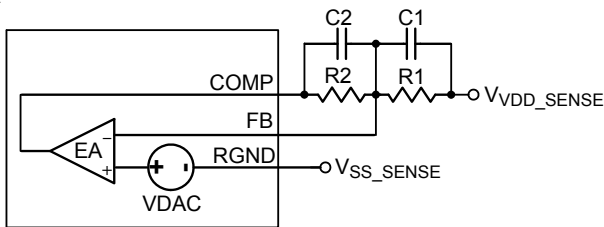

Figure 10. VDD Controller : Compensation Circuit

**TON Setting**

High frequency operation optimizes the application for the smaller component size, trading off efficiency due to higher switching losses. This may be acceptable in ultra portable devices where the load currents are lower and the controller is powered from a lower voltage supply. Low frequency operation offers the best overall efficiency at the expense of component size and board space. Figure 11 shows the On-Time setting Circuit. Connect a resistor (R<sub>TON</sub>) between V<sub>IN</sub> and TONSET to set the on-time of UGATE :

$$t_{ON} (0.5V \leq V_{DAC} < 1.8V) = \frac{24.4 \times 10^{-12} \times R_{TON}}{V_{IN} - V_{DAC}} \tag{11}$$

where t<sub>ON</sub> is the UGATE turn on period, V<sub>IN</sub> is Input voltage of the VDD controller, and V<sub>DAC</sub> is the DAC voltage.

When V<sub>DAC</sub> is larger than 1.8V, the equivalent switching frequency may be over 500kHz, and this too fast switching frequency is unacceptable. Therefore, the VDD controller implements a pseudo constant frequency technology to avoid this disadvantage of CCRCOT topology. When V<sub>DAC</sub> is larger than 1.8V, the on-time equation will be modified to :

$$t_{ON} (V_{DAC} \geq 1.8V) = \frac{13.55 \times 10^{-12} \times R_{TON} \times V_{DAC}}{V_{IN} - V_{DAC}} \tag{12}$$

On-time translates only roughly to switching frequencies. The on-times guaranteed in the Electrical Characteristics are influenced by switching delays in external HS-FET. Also, the dead-time effect increases the effective on-time, which in turn reduces the switching frequency. It occurs only in CCM and during dynamic output voltage transitions.

When the inductor current reverses at light or negative load currents, with reversed inductor current, the phase goes high earlier than normal, extending the on-time by a period equal to the HS-FET rising dead time.

For better efficiency of the given load range, the maximum switching frequency is suggested to be :

$$f_{S(MAX)}(kHz) = \frac{1}{T_{ON} - T_{HS-Delay}} \times \frac{V_{DAC(MAX)} + I_{LOAD(MAX)} \times [R_{ON\_LS-FET} + DCR_L - R_{DROOP}]}{V_{IN(MAX)} + I_{LOAD(MAX)} \times [R_{ON\_LS-FET} - R_{ON\_HS-FET}]} \tag{13}$$

Where f<sub>S(MAX)</sub> is the maximum switching frequency, t<sub>HS-DELAY</sub> is the turn-on delay of HS-FET, V<sub>DAC(MAX)</sub> is the Maximum V<sub>DAC</sub> of application, V<sub>IN(MAX)</sub> is the Maximum application Input voltage, I<sub>LOAD(MAX)</sub> is the maximum load of application, R<sub>ON\_LS-FET</sub> is the Low side FET R<sub>DS(ON)</sub>, R<sub>ON\_HS-FET</sub> is the High side FET R<sub>DS(ON)</sub>, DCR<sub>L</sub> is the equivalent resistance of the inductor, and R<sub>DROOP</sub> is the load line setting.

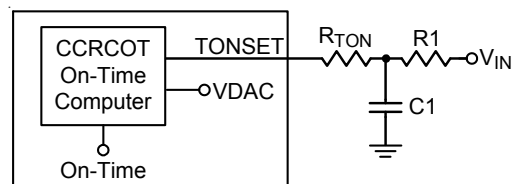

Figure 11. VDD Controller : On-Time Setting with R<sub>C</sub> filter

**Current Sense Setting**

The current sense topology of the VDD controller is continuous inductor current sensing. Therefore, the controller has less noise sensitive. Low offset amplifiers are used for current balance, loop control and over current detection. The ISENxP and ISENxN pins denote the positive and negative input of the current sense amplifier of each phase.

Users can either use a current sense resistor or the inductor's DCR<sub>L</sub> for current sensing. Using the inductor's DCR<sub>L</sub> allows higher efficiency as shown in Figure 12.

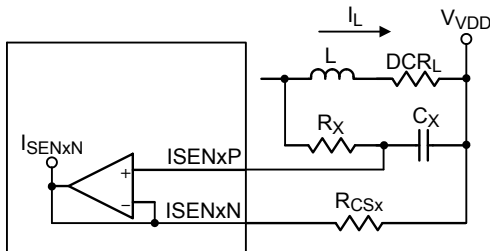

Figure 12. VDD Controller : Lossless Inductor Sensing

In order to optimize transient performance, R<sub>X</sub> and C<sub>X</sub> must be set according to the equation below :

$$\frac{L}{DCR_L} = R_X \times C_X \tag{14}$$

Then the proportion between the phase current, I<sub>L</sub>, and the sensed current, I<sub>SENxN</sub>, is driven by the value of the effective sense resistance, R<sub>CSx</sub>, and the DCR<sub>L</sub> of the inductor. The resistance value of R<sub>CSx</sub> is limited by the internal circuitry. The recommended value is from 500Ω to 1.2kΩ.

$$I_{SENxN} = I_L \times \frac{DCR_L}{R_{CSx}} \tag{15}$$

Considering the inductance tolerance, the resistor R<sub>X</sub> has to be tuned on board by examining the transient voltage. If the output voltage transient has an initial dip below the minimum load line requirement and the recovery is too fast causing a ring back. Vice versa, with a resistance too large the output voltage transient has only a small initial dip with a slow recovery.

Using current sense resistor in series with the inductor can have better accuracy, but the efficiency is a trade-off. Considering the equivalent inductance (L<sub>ESL</sub>) of the current sense resistor, an RC filter is recommended. The RC filter calculation method is similar to the above mentioned inductor equivalent resistance sensing method.

**Per-Phase Over Current Protection**

The VDD controller provides over current protection in each phase. For VDD controller in four-phase configuration, either phase can trigger Per-Phase Over Current Protection (PHOCP).

The VDD controller senses each phase inductor current I<sub>L</sub>, and PHOCP comparator compares sensed current with PHOCP threshold current, as shown in Figure 13.

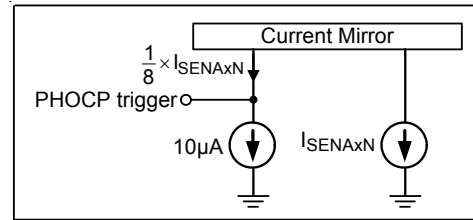

Figure 13. VDD Controller : Per-Phase OCP Setting

The resistor R<sub>CSx</sub> determines PHOCP threshold.

$$I_{L,PERPHASE(MAX)} \times \frac{DCR_L}{R_{CSx}} \times \frac{1}{8} = 10\mu A \tag{16}$$

$$R_{CSx} = \frac{I_{L,PERPHASE(MAX)} \times DCR_L}{8 \times 10\mu A} \tag{17}$$

The controller will turn off all high side/low side MOSFETs to protect CPU if the per-phase over current protection is triggered.

**Current Balance**

The VDD controller implements internal current balance mechanism in the current loop. The VDD controller senses and compares per-phase current signal with average current. If the sensed current of any particular phase is larger than average current, the on-time of this phase will be adjusted to be shorter.

**Initial Offset and External Offset (Over Clocking Offset Function)**

The VDD controller features over clocking offset function which provides the possibility of wide range off set of output voltage. The initial offset function can be implemented through the SVI interface. When the OFS pin voltage < 0.3V at EN rising edge, the initial offset is disabled. The external offset function can be implemented by SET2 pin setting. For example, referring to Table 8, when the both rail external offset functions are enabled, the output voltage is :

$$V_{VDD} = V_{DAC} - I_{LOAD} \times R_{DROOP} + V_{External\_OFS} + V_{Initial\_OFS} \quad (18)$$

$V_{Initial\_OFS}$  is the initial offset voltage set by SVI interface, and the external offset voltage,  $V_{External\_OFS}$  is set by supplying a voltage into OFS pin.

It can be calculated as below :

$$V_{External\_OFS} = V_{OFS} - 1.2V \quad (19)$$

If supplying 1.3V at OFS pin , it will achieve 100mV offset at the output. Connecting a filter capacitor between the OFS pin and GND is necessary. Designers can design the offset slew rate by properly setting the filter bandwidth.

**Table 8. External Offset Function Setting for VDD and VDDNB Controller**

| Core_OFFSET_EN | NB_OFFSET_EN | Description  |
|----------------|--------------|--|
| 0              | 0            | Disable external offset function.  |
| 0              | 1            | NB rail external offset is set by OFS pin voltage.   |
| 1              | 0            | Core rail external offset is set by OFSA pin voltage.  |
| 1              | 1            | Core rail external offset is set by OFS pin voltage, and NB rail external offset is set by OFSA pin voltage. |

### Dynamic VID Enhancement

During a dynamic VID event, the charging (dynamic VID up) or discharging (dynamic VID down) current causes unwanted load-line effect which degrades the settling time performance. The RT8877C will hold the inductor current to hold the load-line during a dynamic VID event. The VDD controller will always enter four-phase configuration when VDD controller receives dynamic VID up and VDD controller will hold the operating state when VDD controller receives dynamic VID down.

### Ramp Amplitude Adjust

When the VDD controller takes phase shedding operation and enters diode emulation mode, the internal ramp of VDD controller will be modified for the reason of stability. In case of smooth transition into DEM, the CCM ramp amplitude should be designed properly. The RT8877C provides SET1 pin for platform users to set the ramp amplitude of the VDD controller in CCM.

### Current Monitoring and Current Reporting

The VDD controller provides current monitoring function via inductor current sensing. In G-NAVP™ technology, the output voltage is dependent on output current, and the current monitoring function is achieved by this characteristic of output voltage. The equivalent output current will be sensed from inductor current sensing and mirrored to IMON pin. The resistor connected to IMON pin determines voltage of the IMON output.

$$V_{IMON} = I_{L,SUM} \times \frac{DCR_L}{R_{CSx}} \times R_{IMON} + 0.64 \quad (20)$$

Where  $I_L$  is the phase current,  $R_{CSx}$  is the effective sense resistance, and  $R_{IMON}$  is the current monitor current setting resistor. Note that the IMON pin cannot be monitored.

The ADC circuit of the VDD controller monitors the voltage variation at the IMON pin from 0V to 3.19375V, and this voltage is decoded into digital format and stored into Output\_Current register. The ADC divides 3.19375V into 511 levels, so  $LSB = 3.19375V / 511 = 6.25mV$ .

### Quick Response

The VDD controller utilizes a quick response feature to support heavy load current demand during instantaneous load transient. The VDD controller monitors the current of the  $V_{VDD\_SENSE}$ , and this current is mirrored to internal quick response circuit. At steady state, this mirrored current will not trigger a quick response. When the  $V_{VDD\_SENSE}$  voltage drops abruptly due to load apply transient, the mirrored current flowing into quick response circuit will also increase instantaneously.

The QR threshold setting for VDD controller refers to Table 4.

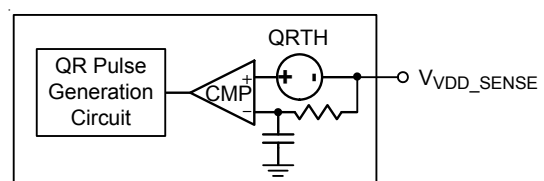

Figure 14. VDD Controller : Quick Response Triggering Circuit

When quick response is triggered, the quick response circuit will generate a quick response pulse. The pulse width of quick response is almost the same with  $t_{ON}$ .

After generating a quick response pulse, the pulse is then applied to the on-time generating circuit, and all the active phases' on-time will be overridden by the quick response pulse.

### Over Current Protection

The RT8877C has dual OCP mechanism. The dual OCP mechanism has two types of thresholds. The first type, referred to as OCP-TDC, is a time and current based threshold. OCP-TDC should trip when the average output current exceeds TDC by some percentage and for a period of time. This period of time is referred to as the trigger delay. The second type, referred to as OCP-SPIKE, is a current based threshold. OCP-SPIKE should trip when the cycle-by-cycle output current exceeds IDDSPIKE by some percentage. If either mechanism trips, then the VDD controller asserts OCP\_L and delays any further action. This delay is called an action delay. Refer to action delay time. After the action delay has expired and the VDD controller has allowed its current sense filter to settle out and the current has not decreased below the threshold, then the VDD controller will turn off both high side MOSFETs and low side MOSFETs of all channels.

Users can set OCP-SPIKE threshold,  $I_{L,SUM(SPIKE)}$ , by the current monitor resistor  $R_{IMON}$  of the following equation :

$$I_{L,SUM(SPIKE)} = \frac{3.19375 - 0.64}{DCR_L} \times \frac{R_{CSx}}{R_{IMON}} \quad (21)$$

And set the OCP-TDC threshold,  $I_{L(TDC)}$ , refer to some percentage of OCP-SPIKE through Table 2.

### Over Voltage Protection (OVP)

The over voltage protection circuit of the VDD controller monitors the output voltage via the  $V_{SEN}$  pin after POR. When VID is lower than 0.9V, once  $V_{SEN}$  exceeds "0.9V + 325mV", OVP is triggered and latched. When VID is larger than 0.9V, once  $V_{SEN}$  exceeds the internal reference by 325mV, OVP is triggered and latched. The VDD controller will try to turn on low side MOSFETs and turn off high side MOSFETs of all active phases of the VDD controller to protect the CPU. When OVP is triggered by one rail, the other rail will also enter soft shut down sequence. A 1μs delay is used in OVP detection circuit to prevent false trigger.

### Negative Voltage Protection (NVP)

During OVP latch state, the VDD controller also monitors the  $V_{SEN}$  pin for negative voltage protection. Since the OVP latch continuously turns on all low side MOSFETs of the VDD controller, the VDD controller may suffer negative output voltage. As a consequence, when the  $V_{SEN}$  voltage drops below 0V after triggering OVP, the VDD controller will trigger NVP to turn off all low side MOSFETs of the VDD controller while the high side MOSFETs remains off. After triggering NVP, if the output voltage rises above 0V, the OVP latch will restart to turn on all low side MOSFETs. The NVP function will be active only after OVP is triggered.

### Under Voltage Protection (UVP)

The VDD controller implements under voltage protection of  $V_{OUT,VDD}$ . If  $V_{SEN}$  is less than the internal reference by 325mV, the VDD controller will trigger UVP latch. The UVP latch will turn off both high side and low side MOSFETs. When UVP is triggered by one rail, the other rail will also enter soft shut down sequence. A 3μs delay is used in UVP detection circuit to prevent false trigger.

### Under Voltage Lock Out (UVLO)

During normal operation, if the voltage at the VCC or DVD pin drops below POR threshold, the VDD controller will trigger UVLO. The UVLO protection forces all high side MOSFETs and low side MOSFETs off by shutting down internal PWM logic drivers. A 3μs delay is used in UVLO detection circuit to prevent false trigger.

### VDDNB Controller

#### VDDNB Controller Disable

The VDDNB controller can be disabled by connecting ISENA1N to a voltage higher than VCC. If not in use, ISENAxP is recommended to be connected to VCC, while PWMx is left floating. When VDDNB controller is disabled, all SVID commands related to VDDNB controller will be rejected.

### Loop Control

The VDDNB controller adopts Richtek's proprietary G-NAVP™ topology. G-NAVP™ is based on the finite gain peak current mode with CCRCOT (Constant Current Ripple





**TON Setting**

High frequency operation optimizes the application for the smaller component size, trading off efficiency due to higher switching losses. This may be acceptable in ultra portable devices where the load currents are lower and the controller is powered from a lower voltage supply. Low frequency operation offers the best overall efficiency at the expense of component size and board space. Figure 18 shows the On-Time setting Circuit. Connect a resistor ( $R_{TON}$ ) between  $V_{IN}$  and TONSETA to set the on-time of UGATE :

$$t_{ON} (0.5V \leq V_{DAC} < 1.8V) = \frac{24.4 \times 10^{-12} \times R_{TON}}{V_{IN} - V_{DAC,VDDNB}} \quad (28)$$

where  $t_{ON}$  is the UGATE turn on period,  $V_{IN}$  is Input voltage of the VDDNB controller, and  $V_{DAC,VDDNB}$  is the DAC voltage.

When  $V_{DAC,VDDNB}$  is larger than 1.8V, the equivalent switching frequency may be over 500kHz, and this too fast switching frequency is unacceptable. Therefore, the VDDNB controller implements a pseudo constant frequency technology to avoid this disadvantage of CCRCOT topology. When  $V_{DAC,VDDNB}$  is larger than 1.8V, the on-time equation will be modified to :

$$t_{ON} (V_{DAC} \geq 1.8V) = \frac{13.55 \times 10^{-12} \times R_{TON} \times V_{DAC,VDDNB}}{V_{IN} - V_{DAC,VDDNB}} \quad (29)$$

On-time translates only roughly to switching frequencies. The on-times guaranteed in the Electrical Characteristics are influenced by switching delays in external HS-FET. Also, the dead-time effect increases the effective on-time, which in turn reduces the switching frequency. It occurs only in CCM and during dynamic output voltage transitions. When the inductor current reverses at light or negative load currents, with reversed inductor current, the phase goes high earlier than normal, extending the on-time by a period equal to the HS-FET rising dead time.

For better efficiency of the given load range, the maximum switching frequency is suggested to be :

$$f_{S(MAX)}(kHz) = \frac{1}{T_{ON} - T_{HS-Delay}} \times \frac{V_{DAC(MAX)} + I_{LOAD(MAX)} \times [R_{ON\_LS-FET} + DCR_L - R_{DROOP}]}{V_{IN(MAX)} + I_{LOAD(MAX)} \times [R_{ON\_LS-FET} - R_{ON\_HS-FET}]} \quad (30)$$

Where  $f_{S(MAX)}$  is the maximum switching frequency,  $t_{HS-DELAY}$  is the turn-on delay of HS-FET,  $V_{DAC(MAX)}$  is the Maximum  $V_{DAC,VDDNB}$  of application,  $V_{IN(MAX)}$  is the Maximum application Input voltage,  $I_{LOAD(MAX)}$  is the maximum load of application,  $R_{ON\_LS-FET}$  is the Low side FET  $R_{DS(ON)}$ ,  $R_{ON\_HS-FET}$  is the High side FET  $R_{DS(ON)}$ ,  $DCR_L$  is the equivalent resistance of the inductor, and  $R_{DROOP}$  is the load line setting.

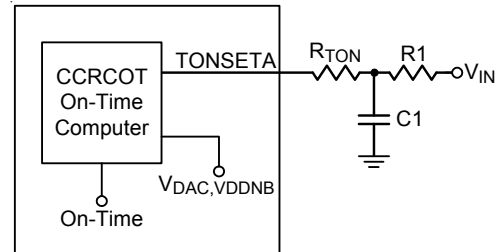

Figure 18. VDDNB Controller : On-Time Setting with  $R_C$  Filter

**Current Sense Setting**

The current sense topology of the VDDNB controller is continuous inductor current sensing. Therefore, the controller has less sensitive noise. Low offset amplifiers are used for current balance, loop control and over current detection. The ISENAXP and ISENAXN pins denote the positive and negative input of the current sense amplifier of each phase.

Users can either use a current sense resistor or the inductor's  $DCR_L$  for current sensing. Using the inductor's  $DCR_L$  allows higher efficiency as shown in Figure 19.

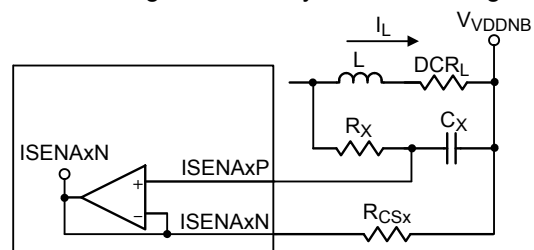

Figure 19. VDDNB Controller : Lossless Inductor Sensing

In order to optimize transient performance,  $R_X$  and  $C_X$  must be set according to the equation below :

$$\frac{L}{DCR_L} = R_X \times C_X \quad (31)$$

Then the proportion between the phase current,  $I_L$ , and the sensed current,  $I_{SENAXN}$ , is driven by the value of the effective sense resistance,  $R_{CSX}$ , and the  $DCR_L$  of the

inductor. The resistance value of  $R_{CSx}$  is limited by the internal circuitry. The recommended value is from  $500\Omega$  to  $1.2k\Omega$ .

$$I_{SENAXN} = I_L \times \frac{DCR_L}{R_{CSx}} \quad (32)$$

Considering the inductance tolerance, the resistor  $R_x$  has to be tuned on board by examining the transient voltage. If the output voltage transient has an initial dip below the minimum load line requirement and the recovery is too fast causing a ring back. Vice versa, with a resistance too large the output voltage transient has only a small initial dip with a slow recovery.

Using current sense resistor in series with the inductor can have better accuracy, but the efficiency is a trade-off. Considering the equivalent inductance ( $L_{ESL}$ ) of the current sense resistor, an RC filter is recommended. The RC filter calculation method is similar to the above mentioned inductor equivalent resistance sensing method.

**Per-Phase Over Current Protection**

The VDDNB controller provides over current protection in each phase. For VDDNB controller in two-phase configuration, either phase can trigger Per-Phase Over Current Protection (PHOCP).

The VDDNB controller senses each phase inductor current  $I_L$ , and PHOCP comparator compares sensed current with PHOCP threshold current, as shown in Figure 20.

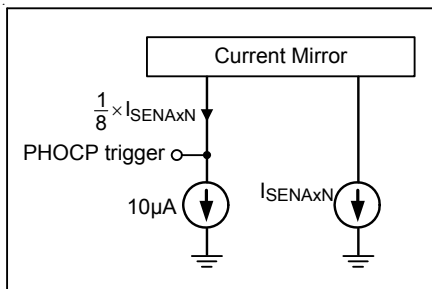

Figure 20. VDDNB Controller : Per-Phase OCP Setting

The resistor  $R_{CSx}$  determines PHOCP threshold.

$$I_{L,PERPHASE(MAX)} \times \frac{DCR_L}{R_{CSx}} \times \frac{1}{8} = 10\mu A \quad (33)$$

$$R_{CSx} = \frac{I_{L,PERPHASE(MAX)} \times DCR_L}{8 \times 10\mu A} \quad (34)$$

The controller will turn off all high side/low side MOSFETs to protect CPU if the per-phase over current protection is triggered.

**Initial Offset and External Offset (Over Clocking Offset Function)**

The VDDNB controller features over clocking offset function which provides the possibility of wide range offset of output voltage. The initial offset function can be implemented through the SVI interface. When the OFSA pin voltage  $< 0.3V$  at EN rising edge, the initial offset is disabled.

The external offset function can be implemented by SET2 pin setting. For example, referring to Table 8, when the both rail external offset functions are enabled, the output voltage is :

$$V_{VDDNB} = V_{DAC,VDDNB} - I_{LOAD} \times R_{DROOP} + V_{External\_OFSA} + V_{Initial\_OFSA} \quad (35)$$

$V_{Initial\_OFSA}$  is the initial offset voltage set by SVI interface, and the external offset voltage,  $V_{External\_OFSA}$  is set by supplying a voltage into OFSA pin.

It can be calculated as below :

$$V_{External\_OFSA} = V_{OFSA} - 1.2V \quad (36)$$

If supplying  $1.3V$  at OFSA pin, it will achieve  $100mV$  offset at the output. Connecting a filter capacitor between the OFSA pin and GND is necessary. Designers can design the offset slew rate by properly setting the filter bandwidth.

**Dynamic VID Enhancement**

During a dynamic VID event, the charging (dynamic VID up) or discharging (dynamic VID down) current causes unwanted load-line effect which degrades the settling time performance. The RT8877C will hold the inductor current to hold the load-line during a dynamic VID event. The VDDNB controller will always enter two-phase configuration when VDDNB controller receives dynamic VID up and VDDNB controller will hold the operating state when VDDNB controller receives dynamic VID down.

**Ramp Amplitude Adjust**

When the VDDNB controller takes phase shedding operation and enters diode emulation mode, the internal ramp of VDDNB controller will be modified for the reason of stability. In case of smooth transition into DEM, the CCM ramp amplitude should be designed properly. The RT8877C provides SET1 pin for platform users to set the ramp amplitude of the VDDNB controller in CCM.

**Current Monitoring and Current Reporting**

The VDDNB controller provides current monitoring function via inductor current sensing. In G-NAVP™ technology, the output voltage is dependent on output current, and the current monitoring function is achieved by this characteristic of output voltage. The equivalent output current will be sensed from inductor current sensing and mirrored to IMONA pin. The resistor connected to IMONA pin determines voltage of the IMONA output.

$$V_{IMONA} = I_{L,SUM} \times 2 \times \frac{DCR_L}{R_{CSx}} \times R_{IMONA} + 0.64 \quad (37)$$

Where  $I_L$  is the phase current,  $R_{CSx}$  is the effective sense resistance, and  $R_{IMONA}$  is the current monitor current setting resistor. Note that the IMONA pin cannot be monitored.

The ADC circuit of the VDDNB controller monitors the voltage variation at the IMONA pin from 0V to 3.19375V, and this voltage is decoded into digital format and stored into Output\_Current register. The ADC divides 3.19375V into 511 levels, so  $LSB = 3.19375V / 511 = 6.25mV$ .

**Quick Response**

The VDDNB controller utilizes a quick response feature to support heavy load current demand during instantaneous load transient. The VDDNB controller monitors the current of the  $V_{VDDNB\_SENSE}$ , and this current is mirrored to internal quick response circuit. At steady state, this mirrored current will not trigger a quick response. When the  $V_{VDDNB\_SENSE}$  voltage drops abruptly due to load apply transient, the mirrored current flowing into quick response circuit will also increase instantaneously.

The QR threshold setting for VDDNB controller refers to Table 5.

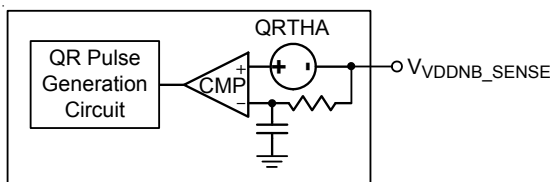

Figure 21. VDDNB Controller : Quick Response Triggering Circuit

When quick response is triggered, the quick response circuit will generate a quick response pulse. The pulse width of quick response is almost the same with  $t_{ON}$ .

After generating a quick response pulse, the pulse is then applied to the on-time generation circuit, and all the active phases' on-times will be overridden by the quick response pulse.

**Over Current Protection**

The RT8877C has dual OCP mechanism. The dual OCP mechanism has two types of thresholds. The first type, referred to as OCP-TDCA, is a time and current based threshold. OCP-TDCA should trip when the average output current exceeds TDCA by some percentage and for a period of time. This period of time is referred to as the trigger delay. The second type, referred to as OCP-SPIKEA, is a current based threshold. OCP-SPIKEA should trip when the cycle-by-cycle output current exceeds IDDSPIKEA by some percentage. If either mechanism trips, then the VDDNB controller asserts OCP\_L and delays any further action. This delay is called an action delay. Refer to action delay time. After the action delay has expired and the VDDNB controller has allowed its current sense filter to settle out and the current has not decreased below the threshold, then the VDDNB controller will turn off both high side MOSFETs and low side MOSFETs of all channels.

Users can set OCP-SPIKEA threshold,  $I_{L,SUM(SPIKEA)}$ , by the current monitor resistor  $R_{IMONA}$  of the following equation :

$$I_{L,SUM(SPIKEA)} = \frac{3.19375 - 0.64}{2 \times DCR_L} \times \frac{R_{CSx}}{R_{IMONA}} \quad (38)$$

And set the OCP-TDCA threshold,  $I_{L(TDCA)}$ , refer to some percentage of OCP-SPIKEA through Table 3.

**Over Voltage Protection (OVP)**

The over voltage protection circuit of the VDDNB controller monitors the output voltage via the  $V_{SENA}$  pin after POR. When VID is lower than 0.9V, once  $V_{SENA}$  exceeds "0.9V + 325mV", OVP is triggered and latched. When VID is larger than 0.9V, once  $V_{SENA}$  exceeds the internal reference by 325mV, OVP is triggered and latched. The VDDNB controller will try to turn on low side MOSFETs and turn off high side MOSFETs of all active phases of the VDDNB controller to protect the CPU. When OVP is triggered by one rail, the other rail will also enter soft shut down sequence. A 1µs delay is used in OVP detection circuit to prevent false trigger.

**Negative Voltage Protection (NVP)**

During OVP latch state, the VDDNB controller also monitors the V<sub>SENA</sub> pin for negative voltage protection. Since the OVP latch continuously turns on all low side MOSFETs of the VDDNB controller, the VDDNB controller may suffer negative output voltage. As a consequence, when the V<sub>SENA</sub> voltage drops below 0V after triggering OVP, the VDDNB controller will trigger NVP to turn off all low side MOSFETs of the VDDNB controller while the high side MOSFETs remains off. After triggering NVP, if the output voltage rises above 0V, the OVP latch will restart to turn on all low side MOSFETs. The NVP function will be active only after OVP is triggered.

**Under Voltage Protection (UVP)**

The VDDNB controller implements under voltage protection of V<sub>OUT,VDDNB</sub>. If V<sub>SENA</sub> is less than the internal reference by 325mV, the VDDNB controller will trigger UVP latch. The UVP latch will turn off both high side and low side MOSFETs. When UVP is triggered by one rail, the other rail will also enter soft shut down sequence. A 3μs delay is used in UVP detection circuit to prevent false trigger.

**Under Voltage Lock Out (UVLO)**

During normal operation, if the voltage at the VCC or DVD pin drops below POR threshold, the VDDNB controller will trigger UVLO. The UVLO protection forces all high side MOSFETs and low side MOSFETs off by shutting down internal PWM logic drivers. A 3μs delay is used in UVLO detection circuit to prevent false trigger.

**Thermal Considerations**

The junction temperature should never exceed the absolute maximum junction temperature T<sub>J(MAX)</sub>, listed under Absolute Maximum Ratings, to avoid permanent damage to the device. The maximum allowable power dissipation depends on the thermal resistance of the IC package, the PCB layout, the rate of surrounding airflow, and the difference between the junction and ambient temperatures. The maximum power dissipation can be calculated using the following formula :

$$P_{D(MAX)} = (T_{J(MAX)} - T_A) / \theta_{JA}$$

where T<sub>J(MAX)</sub> is the maximum junction temperature, T<sub>A</sub> is

the ambient temperature, and θ<sub>JA</sub> is the junction-to-ambient thermal resistance.

For continuous operation, the maximum operating junction temperature indicated under Recommended Operating Conditions is 125°C. The junction-to-ambient thermal resistance, θ<sub>JA</sub>, is highly package dependent. For a WQFN-52L 6x6 package, the thermal resistance, θ<sub>JA</sub>, is 26.5°C/W on a standard JEDEC 51-7 high effective-thermal-conductivity four-layer test board. The maximum power dissipation at T<sub>A</sub> = 25°C can be calculated as below :

$$P_{D(MAX)} = (125^{\circ}\text{C} - 25^{\circ}\text{C}) / (26.5^{\circ}\text{C/W}) = 3.77\text{W for a WQFN-52L 6x6 package.}$$

The maximum power dissipation depends on the operating ambient temperature for the fixed T<sub>J(MAX)</sub> and the thermal resistance, θ<sub>JA</sub>. The derating curves in Figure 22 allows the designer to see the effect of rising ambient temperature on the maximum power dissipation.

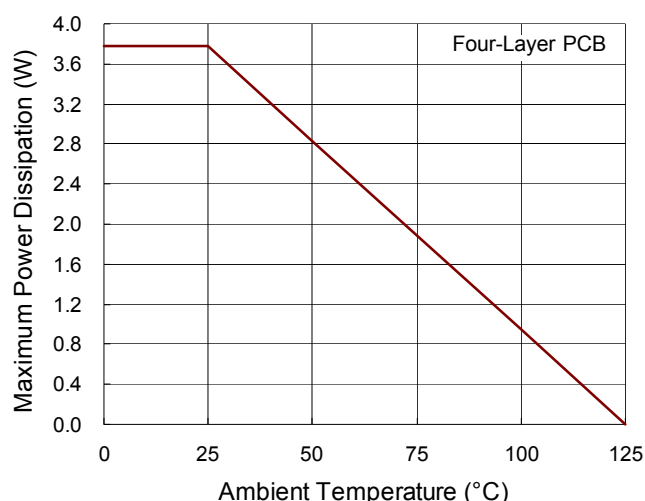
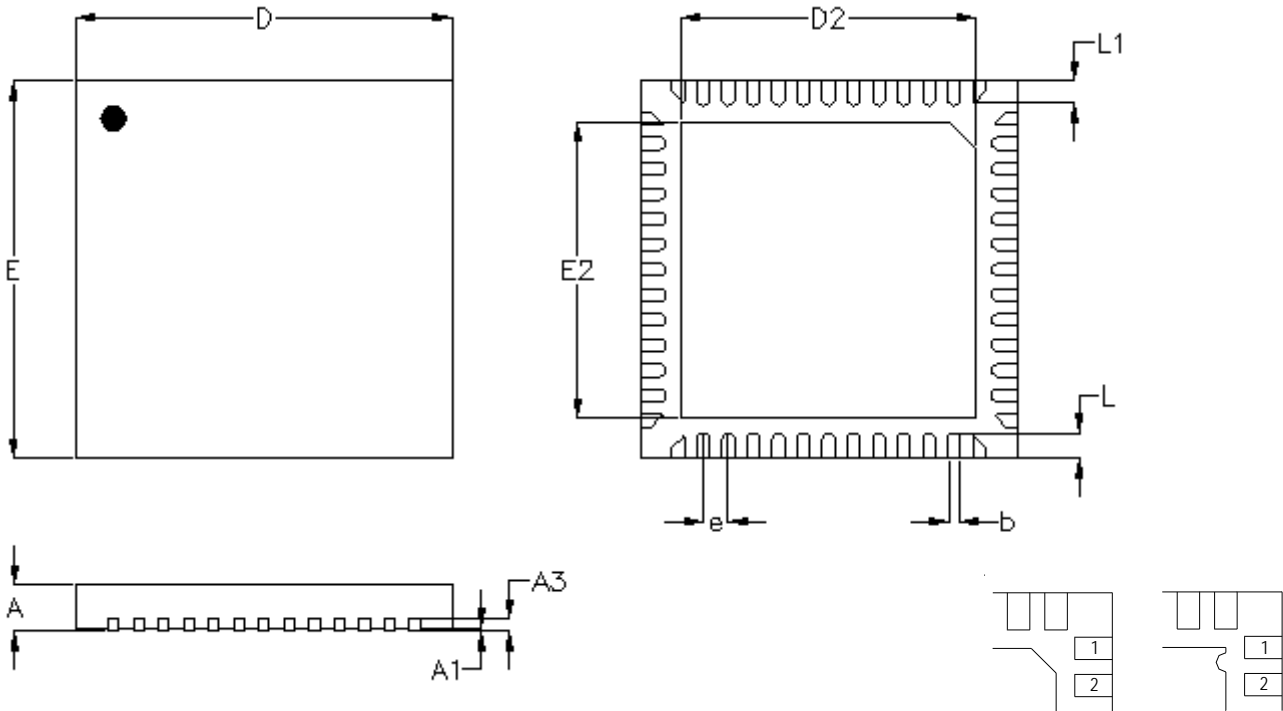

Figure 22. Derating Curve of Maximum Power Dissipation

Outline Dimension



**DETAIL A**

Pin #1 ID and Tie Bar Mark Options

Note : The configuration of the Pin #1 identifier is optional, but must be located within the zone indicated.

| Symbol | Dimensions In Millimeters |       | Dimensions In Inches |       |
|--------|---------------------------|-------|----------------------|-------|
|        | Min.                      | Max.  | Min.                 | Max.  |
| A      | 0.700                     | 0.800 | 0.028                | 0.031 |
| A1     | 0.000                     | 0.050 | 0.000                | 0.002 |
| A3     | 0.175                     | 0.250 | 0.007                | 0.010 |
| b      | 0.150                     | 0.250 | 0.006                | 0.010 |
| D      | 5.950                     | 6.050 | 0.234                | 0.238 |
| D2     | 4.650                     | 4.750 | 0.183                | 0.187 |
| E      | 5.950                     | 6.050 | 0.234                | 0.238 |
| E2     | 4.650                     | 4.750 | 0.183                | 0.187 |
| e      | 0.400                     |       | 0.016                |       |
| L      | 0.350                     | 0.450 | 0.014                | 0.018 |
| L1     | 0.300                     | 0.400 | 0.012                | 0.016 |

**W-Type 52L QFN 6x6 Package**

**Richtek Technology Corporation**

14F, No. 8, Tai Yuen 1<sup>st</sup> Street, Chupei City

Hsinchu, Taiwan, R.O.C.

Tel: (8863)5526789

Richtek products are sold by description only. Richtek reserves the right to change the circuitry and/or specifications without notice at any time. Customers should obtain the latest relevant information and data sheets before placing orders and should verify that such information is current and complete. Richtek cannot assume responsibility for use of any circuitry other than circuitry entirely embodied in a Richtek product. Information furnished by Richtek is believed to be accurate and reliable. However, no responsibility is assumed by Richtek or its subsidiaries for its use; nor for any infringements of patents or other rights of third parties which may result from its use. No license is granted by implication or otherwise under any patent or patent rights of Richtek or its subsidiaries.